

# Round20 acoustic | Productsheet

design Robert Bronwasser

Cascando



De Projectinrichter 

[www.deprojectinrichter.com](http://www.deprojectinrichter.com)  
088 - 650 12 34

## Models & Measurements

### Round20 Acoustic

Art.nr	h x w x d	kg.
4132.	180 x 84 x 50	8,5 kg
4133.	180 x 124 x 50	12,5 kg
4134.	180 x 164 x 50	16,5 kg

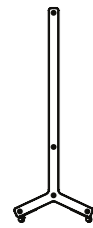
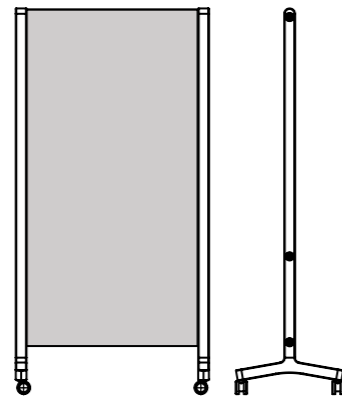

Y-staander = .Y

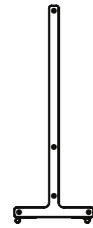

T-staander = .T



Aluminium-staander = .A



Wood-staander = .W

## Technical specifications

### Material + color

Wood-frame

Upright  
Oak wood



Natural

Bars  
Anodised aluminium

### Material + color

Y-frame, T-frame, T2-frame and

Upright  
MDF



Black



White

Bars  
Anodised aluminium

### Material + color

Alu-frame

Upright  
Aluminium and steel

Bars  
Anodised aluminium

## Optional

### Whiteboard

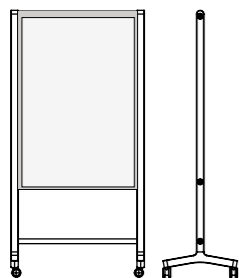

\*Acoustic panels combined with whiteboards are 120cm in height

\*To be ordered separately



## Fabric

Fabric group P0, P1 or P2

### FABRIC FOR PANELS AND ACOUSTIC ELEMENTS

Category	Fabric	Producer	Composition
P0	Cara	Camira	100% Polypropylene
P1	Twist *	Gabriel	Trevira
	Twist Melange *	Gabriel	Trevira
	Soul	Gabriel	100% wool
P2	Blazer Lite	Camira	100% wool

Other fabrics on request

\* Twist en Twist Melange not in combination with acoustic class A.

## Maintenance instructions

Keep clean with a cotton cloth. Remove stains with a damp cloth or with diluted all-purpose cleaner. Wipe off the surface with a dry cloth. Never use wax, wax containing products, product with a scouring effect and solvents.

Download fabric maintenance from our website: [www.cascando.nl/maintenance](http://www.cascando.nl/maintenance)

## Warranty

Our products are covered by a 2-year warranty.

Cascando Products b.v.  
Impact 2  
NL-6921 RZ Duiven  
The Netherlands

T +31(0)263519603  
F +31(0)263519808  
E [design@cascando.nl](mailto:design@cascando.nl)  
I [www.cascando.nl](http://www.cascando.nl)



# Round20 wood | Product sheet

design Robert Bronwasser

Cascando



## Models & Measurements

### Wood-frame

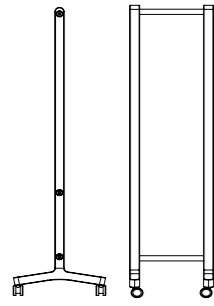

Art.nr	h x w x d	kg.
4120.	180 x 44 x 50	8,6 kg
4121.	180 x 64 x 50	8,8 kg
4122.	180 x 84 x 50	9 kg
4123.	180 x 104 x 50	9,2 kg
4124.	180 x 124 x 50	9,4 kg
4125.	180 x 164 x 50	10,2 kg

### Wood-frame

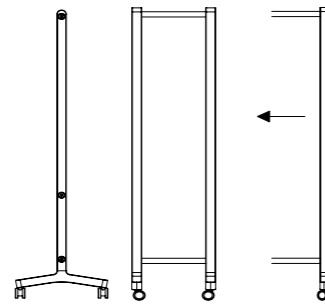

Art.nr	h x w x d	kg.
4126.	180 x 40 x 50	5,4 kg
4127.	180 x 60 x 50	5,6 kg
4094.	180 x 80 x 50	5,8 kg
4095.	180 x 100 x 50	6 kg
4096.	180 x 120 x 50	6,2 kg
4097.	180 x 160 x 50	7 kg

### Mirror



To be ordered seperately  
For round20 basic element w=43

### Whiteboard

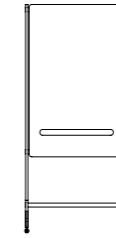

To be ordered seperately  
For round20 basic element w=83

### Whiteboard

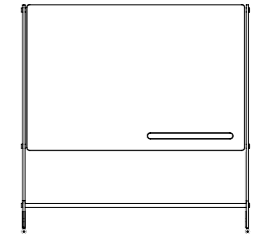

To be ordered seperately  
For round20 basic element w=163

### Flipchart holder

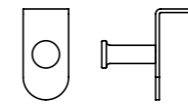

2 x 2 x 5  
Set of 2

### Brochure holder

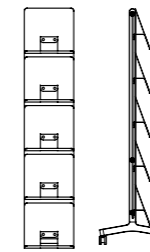

To be ordered seperately  
For round20 basic element w=43  
5 brochure holders, A4+  
Single sided

### Brochure holder

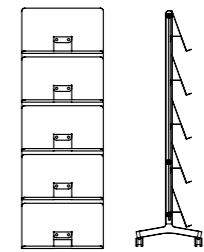

To be ordered seperately  
For round20 basic element w=63  
5 brochure holders, A3+  
Single sided

## Technical specifications

### Material + color

Wood-frame

Upright  
Oak wood



Natural

Bars  
Anodised aluminium

### Box size

174,5 x 66 x 6

### Weight

4120.	8,6	kg	4126.	5,4	kg
4121.	8,8	kg	4127.	5,6	kg
4122.	9	kg	4128.	5,8	kg
4123.	9,2	kg	4129.	6	kg
4124.	9,4	kg	4130.	6,2	kg
4125.	10,2	kg	4131.	7	kg

## Accessories

### Coat hook

4044



To be ordered seperately

### Coat hanger

4055

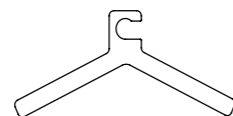

To be ordered seperately

### Brochure holder

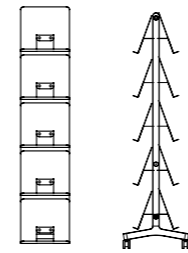

To be ordered seperately  
For round20 basic element w=43  
2 x 5 brochure holders, A4+  
Double sided

### Brochure holder

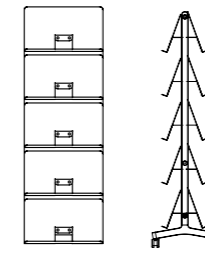

To be ordered seperately  
For round20 basic element w=63  
2 x 5 brochure holders, A3+  
Double sided

### Acoustic panel

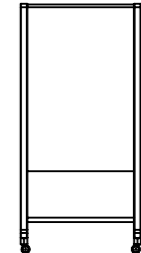

To be ordered seperately

## Maintenance instructions

Keep clean with a cotton cloth. Remove stains with a damp cloth or with diluted all-purpose cleaner. Wipe off the surface with a dry cloth. Never use wax, wax containing products, product with a scouring effect and solvents.

## Warranty

Our products are covered by a 2-year warranty.

