Understanding and Specifying Steelcase Karman Work Chairs

Product Details

Steelcase Karman	74
Dimensions	80

Specifying

Standard-Back Work Chair

Steelcase Karman Standard-Back Work Chair with Intermix Performance Textile	82
---	----

Stool

Steelcase Karman Work Stool with Intermix Performance Textile	83
---	----

High-Back Work Chair

Steelcase Karman High-Back Work Chair with Intermix Performance Textile	84
---	----

Accessories

85

Steelcase Karman



Now available as a CarbonNeutral product, making sure our commitment to a more sustainable future helps yours too.

Steelcase Karman design relies more on physics than mechanism – intuitively responding to your movement and weight while providing effortless comfort. Its proprietary performance textile, Intermix, creates support that never sags or feels stiff for people of all shapes and sizes.

Back frame and seat shell are flexible, encouraging healthy user movement.

Lumbar height adjusts over 3 1/2" to provide additional lower back support and is available as an option.

Arm caps can pivot independently 28° in and 24° out to accommodate individual user preferences.

Arm depth can retract 2" to allow user to get closer to the worksurface and into tight corners.

Comfort dial back control provides four settings for the user's personal preference and work style.

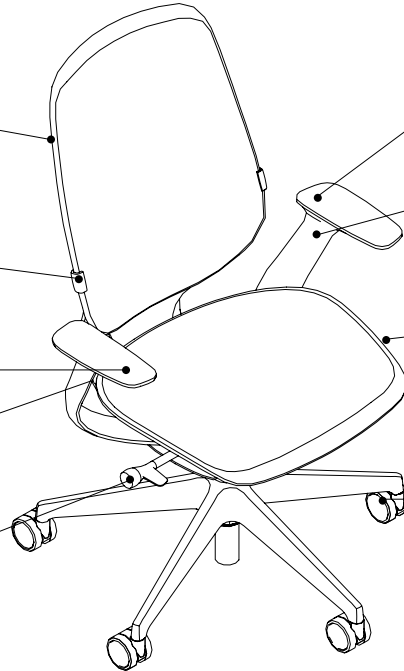

Arm width adjusts 4 5/8" overall to support forearms in neutral position.

Arm height can adjust independently within a 4" range to help relieve upper back and shoulder fatigue.

Seat height adjusts within a 5" range with a pneumatic adjustment mechanism. A 4" or 7" range is available as an option. Stools have a 8" range.

Casters have hard, dual-wheels that roll smoothly on carpets. They are 2 1/2" for increased mobility. Soft, dark grey treaded, dual-wheel roll-control casters are available for use on hard floors or mats. Glides are also available as an option.
Tip: Do not roll the chair across asphalt during installation as this may damage the casters.

Product Details

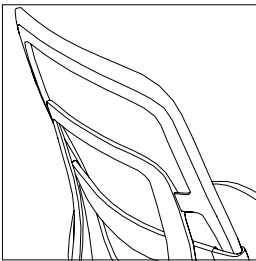

LiveBack technology allows the backrest to flex and contour to mimic the natural movement of the spine and reinforce a healthy posture.

Patented hybrid seat

Suspension seat with integrated cushioning provides maximum comfort right where you need it most.

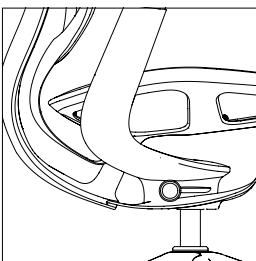

Advanced weight-activated mechanism with a natural fluid motion keeps users oriented to their work.

Organic movement is achieved with this advanced weight-activated mechanism that responds automatically to your body with appropriate support as you sit and change postures in every direction.

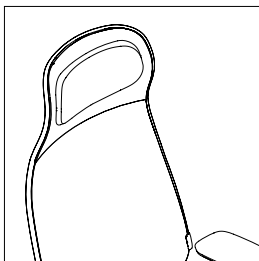

Available in standard-back and high-back

configurations. High-back features an adjustable neck support pillow standard, allowing users to gently support their neck and head during recline. Neck support pillow adjusts 3" vertically, and measures 5³/₄"H x 10"W. Pillow follows Intermix selection of the seat and back configuration, and is field serviceable only on high-back chairs that were originally specified with a neck support pillow. Pillow is not able to be installed on existing Steelcase Karman chairs that did not originally have a neck support pillow specified.

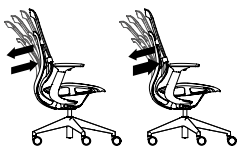

Weight-activated setting

Boosted setting

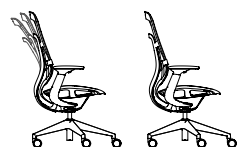

Mid-back stop recline setting

Upright back stop setting

Comfort dial has four settings that allow for the user's personal preference and work style: (1) weight-activated setting; (2) boosted tension setting that has approximately 20% more resistance than your body is providing; (3) mid-stop recline setting; and (4) an upright lock setting.

Comfort edge on the back and seat frames

The ultra-light back and seat frames flex to eliminate hard edges and pressure points on your legs and body and comfort edge allows users to lean back or sit sideways.

Proprietary Intermix

The versatility from the Intermix proprietary weave process results in three variations:

Intermix is classic and translucent with a more traditional mesh look and feel.

Intermix Shift is color-shifting and provocative with a dynamic visual that changes with light and viewing angle.

Intermix Opaque is luxurious and residential with the hand-feel of upholstery.

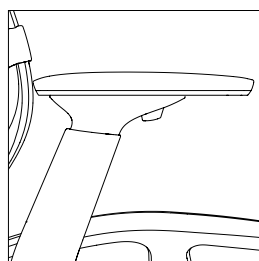

Rectilinear arms with soft caps are standard.

Uncartoned request on your dealer purchase order means Steelcase Karman chairs will ship fully assembled.

Cartoned request on your dealer purchase order means Steelcase Karman will ship knocked down with the chair base and pneumatic cylinder separated from the rest of the chair. This allows for shipment in a smaller carton. Assembly by a qualified dealer installer is required.

Tip: Assembly instructions are included.



CarbonNeutral.com

CarbonNeutral product

Karman helps organizations achieve their carbon emissions goals. Add **CN** to the end of the style number to specify Karman with CarbonNeutral product certification.

Adjustment Features

Adjustability instructions are included with every chair.

Seat Adjustments

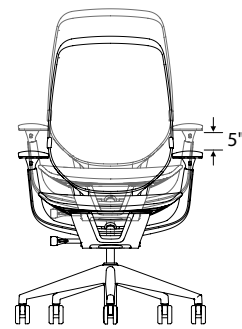

Seat height adjusts pneumatically. To lower, hold handle up while seated. To raise, hold handle up and keep your weight off the chair. Standard range of adjustability is 5" from 16"H to 21"H. A short 4" range of adjustability (14"H to 18"H) and a tall 7" range of adjustability (21"H to 28"H) are available as options. An 8" range of adjustability (21"H to 29"H) is available on stools.

Back Adjustments

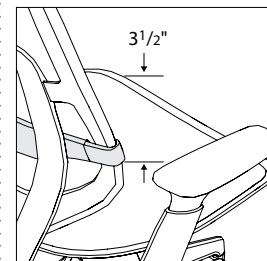

Lumbar height adjusts 3¹/₂" (4" to 7¹/₂" from seat) by grabbing exposed tabs and sliding the lumbar support up or down.

Lumbar is available as an option or as a field installed accessory. When ordered initially, the lumbar ships assembled to the chair. When ordered at a later date, the lumbar ships in its own carton and is easily field installed.

Arm Adjustments

4D arms have fully adjustable armrests that raise up and down, pivot in and out, and shift in all directions letting your arms and shoulders fall naturally into place.

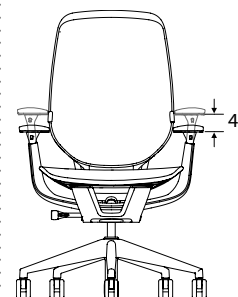

Arm height adjusts independently within a range of 4". Push button on outside and under arm cap in while moving arms up or down. Releasing buttons locks arms in position.

Steelcase Karman , continued

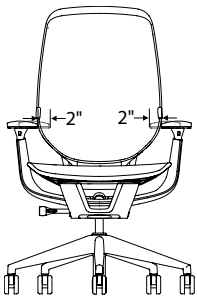

Arm width can be adjusted 2" each, 4" overall. Grasp arm cap and move in or out.

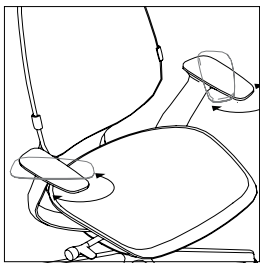

Arms pivot independently, 28° inward and 24° outward. Grasp arm and push front to left or right.

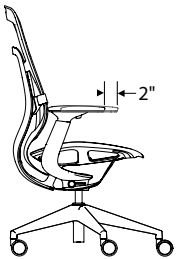

Arm depth adjusts by sliding arm caps back 2". Friction-fit keeps arms in position.

Other Features

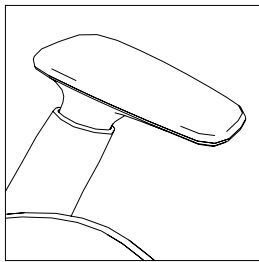

Height-only adjustable arm is also available and adjusts 4".



Fixed arm models are also available in plastic and polished aluminum finishes.

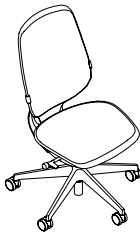

Armless models are also available.

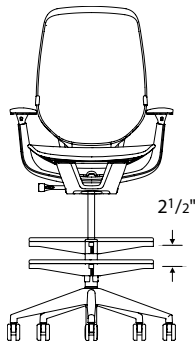

Foot ring height on stools adjusts by rotating it counterclockwise to unlock. Then raise or lower ring to desired position before rotating it clockwise to lock. The foot ring has a diameter of 20".

Soft dual-wheel roll-control casters feature an internal brake that activates when the chair is not under load to reduce shifting when user stands up.

Hubless hard wheel casters, hubless soft roll control wheel casters, and hard glides are available as options.

Steelcase Karman Finish Options

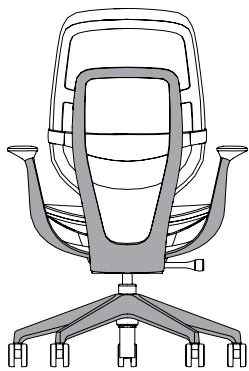
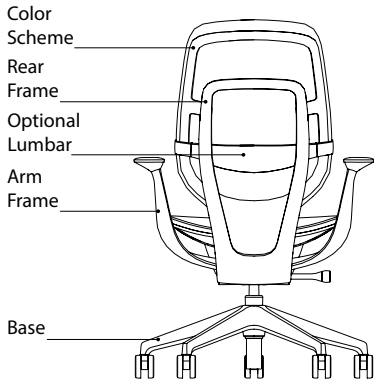

Rear Frame + Arm Frame + Base

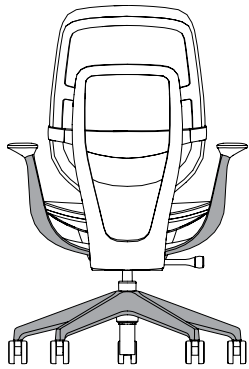

Arm Frame + Base

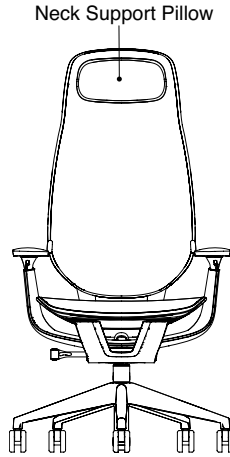

High-Back Work Chair + Neck Support Pillow

Proprietary Textile Intermix

- KR07 Platinum
- KR08 Black
- KR09 Baltic
- KR10 Bright Peacock
- KR11 Merlot

Intermix Shift

- KR12 Red/ Blue
- KR13 Blue/Gold

Intermix Opaque

- KR14 Seagull
- KR15 Platinum
- KR16 Bronze
- KR17 Black
- KR18 Baltic
- KR19 Peacock
- KR20 Merlot

Hard components

Note: Finishes are determined by color scheme, see page 78 for color scheme matrix.

- Color scheme
- Platinum Solid
 - Black
 - Seagull
 - Merle

Rear frame

- 6205 Black
- 7190 Platinum Solid
- 7243 Seagull
- 7360 Merle
- 4B20 Obsidian
- 4B22 Matte Brass
- 4B23 Burnished Bronze
- 4B24 Night Bronze
- 4B25 Matte Copper
- 4B26 Smoked Mica
- 4B29 Cast Iron

Base

- 6205 Black
- 7190 Platinum Solid
- 7243 Seagull
- 7360 Merle
- 8046 Polished Aluminum
- 4B20 Obsidian
- 4B22 Matte Brass
- 4B23 Burnished Bronze
- 4B24 Night Bronze
- 4B25 Matte Copper
- 4B26 Smoked Mica
- 4B29 Cast Iron

Note: if short cylinder is specified, Lux Coatings paints cannot be applied to base. If the extended cylinder is specified, all base finishes are available.

Arm frame

- 7190 Platinum Solid
- 7207 Black
- 7243 Seagull
- 7360 Merle
- 8046 Polished Aluminum
- 4B20 Obsidian
- 4B22 Matte Brass
- 4B23 Burnished Bronze
- 4B24 Night Bronze
- 4B25 Matte Copper
- 4B26 Smoked Mica
- 4B29 Cast Iron

Arm caps, casters, cylinder, and stool ring

- 6059 Sterling Dark
- 6205 Black

Note: When short and extended cylinders are specified, cylinder color will always be 6205 black.

Lumbar

- 6053 Seagull
- 6205 Black
- 6249 Platinum Solid
- 6527 Merle

Coat hanger

- 6059 Sterling Dark
- 6205 Black

All Steelcase Karman with standard Intermix complies with requirements of the state of California. Technical Bulletin 117-2013. All chairs are labeled to be in compliance with California 117-2013.

Color Scheme Matrix

Steelcase Karman

Frame Package Color Scheme Matrix

Color Scheme	Rear Frame	Lower Shell*	Arm Frame	Back Shell*	Seat Shell*	Lumbar**
Platinum Solid	7190 Platinum Solid	7190 Platinum Solid	7190 Platinum Solid	6249 Platinum Solid	6249 Platinum Solid	6249 Platinum Solid
Black	7207 Black	7207 Black	7207 Black	6205 Black	6205 Black	6205 Black
Seagull	7243 Seagull	7243 Seagull	7243 Seagull	6053 Seagull	6059 Sterling Dark	6053 Seagull
Merle	7360 Merle	7360 Merle	7360 Merle	6527 Merle	6527 Merle	6527 Merle

Tip: Lux Coatings are available as an option on one of the two following combinations: rear frame, arm frame, and base or arm frame and base.

Tip: Color scheme selection determines finishes for all other non-specifiable components (arm cap, back and seat frame, lumbar, cylinder, foot ring, and caster color).

Tip: If Lux Coatings are selected for frame finish, the same Lux Coatings finish will be applied to the rear frame, arm frame, and base.

Tip: Polished aluminum is available as an option on base and arm frame specified separately, and cannot be combined with Lux Coatings.

Tip: If short or extended cylinder is selected, cylinder will always be Black 6205 Lux Coatings cannot be specified.

** Denotes components that are not specifiable, they default based on color scheme selected. Seagull color scheme comes standard with contrasting sterling dark comfort edges. Black, merle, and platinum come standard with coordinating comfort edge.*

*** Unless ordered as a separate style: **419LUMBAR, 419COATHANGER.***

Base	Cylinder*	Arm Caps*	Casters*	Comfort Edge	Coat Hanger**
7190 Platinum Solid	6205 Black	6205 Black	6205 Black	7190 Platinum Solid	6205 Black
6205 Black	6205 Black	6205 Black	6205 Black	6205 Black	6205 Black
7243 Seagull	6059 Sterling	6059 Sterling Dark	6059 Sterling Dark	6059 Sterling Dark	6059 Sterling Dark
7360 Merle	6205 Black	6205 Black	6205 Black	7360 Merle	6205 Black

Note: Seagull color scheme comes standard with contrasting sterling dark comfort edges. Black, merle, and platinum come standard with coordinating comfort edges, matching color scheme selections.

Dimensions

Steelcase Karman

Steelcase Karman

Features	Overall Depth	Overall Width	Overall Height	Seat height (from floor)	Fixed Seat Depth	Fixed Seat Width	Functional Seat Depth	Ring Height from Floor
Standard-back work chair	26 ¹ / ₈ "	26 ¹ / ₈ "	39 ¹ / ₈ " to 43 ¹ / ₂ "	15 ³ / ₁₆ " to 20 ⁷ / ₁₆ "	16 ³ / ₁₀ "	19 ¹ / ₄ "	N.A.	N.A.
			37 ⁵ / ₈ " to 41 ¹ / ₂ " (low opt)	14 ¹ / ₈ " to 18" (low opt)				
			43 ³ / ₄ " to 50 ¹ / ₈ " (high opt)	20 ¹ / ₄ " to 27 ⁵ / ₈ " (high opt)				
High-back work chair	26 ¹ / ₈ "	26 ¹ / ₈ "	46 ³ / ₄ " to 51 ¹ / ₈ "	15 ³ / ₁₆ " to 20 ⁷ / ₁₆ "	16 ³ / ₁₀ "	19 ¹ / ₄ "	N.A.	N.A.
			45 ¹ / ₄ " to 49 ¹ / ₈ " (low opt)	14 ¹ / ₈ " to 18" (low opt)				
			51 ³ / ₈ " to 57 ³ / ₄ " (high opt)	20 ¹ / ₄ " to 27 ⁵ / ₈ " (high opt)				
Stool	26 ¹ / ₈ "	26 ¹ / ₈ "	45 ¹ / ₈ " to 52 ³ / ₈ "	21 ⁵ / ₈ " to 28 ⁷ / ₈ "	16 ³ / ₁₀ "	19 ¹ / ₄ "	N.A.	11 ¹ / ₂ " to 13"

Note: The Steelcase Karman chair complies with current BIFMA G1 Ergonomic Guidelines, listed above.

Back Width	Back Height from Seat	Back Lumbar Height	Width between Arms	Arm Height from Seat	Seat Pan Angle	Angle between Seat and Back	Weight Limit
15 ³ / ₈ "	25"	4" to 7 ¹ / ₂ " adjustable	Fixed: 20 ¹ / ₂ " 1D: 19 ³ / ₈ " to 20 ¹ / ₈ " 4D: 17 ¹ / ₂ " to 11 ¹ / ₈ "	Fixed: 7 ³ / ₄ " 1D: 7 ¹ / ₂ " to 11 ¹ / ₂ " 4D: 7 ¹ / ₂ " to 11 ¹ / ₂ "	-1° to 7°	-97° to -112°	350-lbs
15 ³ / ₈ "	32 ⁵ / ₈ "	4" to 7 ¹ / ₂ " adjustable	Fixed: 20 ¹ / ₂ " 1D: 19 ³ / ₈ " to 20 ¹ / ₈ " 4D: 17 ¹ / ₂ " to 11 ¹ / ₈ "	Fixed: 7 ³ / ₄ " 1D: 7 ¹ / ₂ " to 11 ¹ / ₂ " 4D: 7 ¹ / ₂ " to 11 ¹ / ₂ "	-1° to 7°	-97° to -112°	350-lbs
15 ³ / ₈ "	25"	4" to 7 ¹ / ₂ " adjustable	Fixed: 20 ¹ / ₂ " 1D: 19 ³ / ₈ " to 20 ¹ / ₈ " 4D: 17 ¹ / ₂ " to 22 ¹ / ₈ "	Fixed: 7 ³ / ₄ " 1D: 7 ¹ / ₂ " to 11 ¹ / ₂ " 4D: 7 ¹ / ₂ " to 11 ¹ / ₂ "	-1° to 7°	-97° to -112°	350-lbs

Note: The Steelcase Karman chair complies with current BIFMA G1 Ergonomic Guidelines, listed above.

Steelcase Karman Work Chair with Intermix Performance Textile

Standard Height Back with Performance Intermix on Seat and Back



Tip: For more information regarding color schemes, see page 78.

Tip: Leather, vinyl, Customer's Own Material (COM), and Customer's Own Leather (COL) are not available on Steelcase Karman.

Tip: Rear frame, arm frame, and base finish matches color scheme unless Lux Coatings frame is selected.

Tip: If Lux Coatings is selected, rear frame, arm frame, and base will match.

Tip: Polished aluminum base and arms are not available if Lux Coatings is chosen for frame finish.

Tip: Intermix selection is applied on both seat and back and must be the same on both.

Tip: Soil-retardant treatment not available.

Tip: Hard casters are recommended for use on soft flooring (i.e., carpet). Soft casters are recommended for use on hard flooring (i.e., hardwood) to help prevent scuffs and damage.

Standard Includes		Required to Specify
<ul style="list-style-type: none"> ▶ Need help? Product details, page 74 	<ul style="list-style-type: none"> 5" pneumatic seat-height adjustment (16"–21") Passive seat edge angle Frame, seat shell, and five-arm plastic base: textured paint 4D arms, rectilinear, height-, width-, pivot-, and depth-adjustable arms Intermix price group 1 on seat and back 2½"-diameter, hard dual-wheeled casters: black 	<ol style="list-style-type: none"> 1 Style number 2 Color scheme (see below under Required Selections) 3 Intermix color for seat and back 4 Options, if selected (see below) <ul style="list-style-type: none"> ▶ See <i>Surface Materials</i>, page 634.

Required Selections	U.S. Price	Required to Specify
Color Scheme		
<ul style="list-style-type: none"> Black Merle Platinum Seagull 	<ul style="list-style-type: none"> No cost No cost No cost No cost 	<ul style="list-style-type: none"> Specify with 6205 Black. Specify with 7360 Merle. Specify with 7190 Platinum. Specify with 7243 Seagull.

Options	U.S. Price	Required to Specify
Surface Materials		
Intermix on seat and back		
<ul style="list-style-type: none"> Intermix price group 1 Intermix Shift price group 2 Intermix Opaque price group 3 	<ul style="list-style-type: none"> No cost +\$ 36 +\$ 68 	<ul style="list-style-type: none"> Specify Intermix color number. Specify Intermix Shift color number. Specify Intermix Opaque color number.
Rear frame		
<ul style="list-style-type: none"> Lux Coatings 	<ul style="list-style-type: none"> +\$ 49 	<ul style="list-style-type: none"> Specify Lux Coatings color number.
Base		
<ul style="list-style-type: none"> Lux Coatings Polished aluminum base 	<ul style="list-style-type: none"> +\$131 +\$186 	<ul style="list-style-type: none"> Specify Lux Coatings color number. Specify with polished aluminum base.
Arms		
<ul style="list-style-type: none"> Lux Coatings 	<ul style="list-style-type: none"> +\$ 85 	<ul style="list-style-type: none"> Specify Lux Coatings color number.
Arms		
<ul style="list-style-type: none"> Height-adjustable arms Fixed arms Armless Polished aluminum fixed arms 	<ul style="list-style-type: none"> –\$ 71 –\$144 –\$367 +\$100 	<ul style="list-style-type: none"> Specify with height-adjustable arms. Specify with fixed arms. Specify without arms. Specify with polished aluminum fixed arms.
Lumbar		
<ul style="list-style-type: none"> Adjustable lumbar support 	<ul style="list-style-type: none"> +\$ 93 	<ul style="list-style-type: none"> Specify with adjustable lumbar.
Seat Height		
<ul style="list-style-type: none"> 4" low-range pneumatic seat-height adjustment (14"–18") 7" high-range pneumatic seat-height adjustment (20"–27") 	<ul style="list-style-type: none"> +\$ 82 +\$ 82 	<ul style="list-style-type: none"> Specify with low-range cylinder. Specify with high-range cylinder.
Casters		
<ul style="list-style-type: none"> Soft, dark grey treaded, dual-wheel roll-control casters for use on hard floors Hard, black interior/black treaded hubless casters for use on soft floors Soft, black interior/black treaded hubless casters, for use on hard floors 	<ul style="list-style-type: none"> +\$ 36 +\$140 +\$179 	<ul style="list-style-type: none"> Specify with soft casters. Specify with hard, hubless casters. Specify with soft, hubless casters.
Glides		
<ul style="list-style-type: none"> Glides: plastic 	<ul style="list-style-type: none"> +\$ 36 	<ul style="list-style-type: none"> Specify with glides.
Coat Hanger		
<ul style="list-style-type: none"> Field-installed coat hanger 	<ul style="list-style-type: none"> +\$ 45 	<ul style="list-style-type: none"> Specify with coat hanger.
CarbonNeutral Product		
<ul style="list-style-type: none"> CarbonNeutral product certification 	<ul style="list-style-type: none"> +\$ 35 	<ul style="list-style-type: none"> Add suffix CN to the end of the style number.

Specification Information

Style Number	U.S. Base Price
419A000	\$1744



For Canadian Pricing
Multiply U.S. Price by the Canadian price factor.
▶ See page 1 for details.

Steelcase Karman Work Stool with Intermix Performance Textile

Steelcase Karman Work Stool with Intermix Performance Textile

Standard Height Back with Performance Intermix on Seat and Back

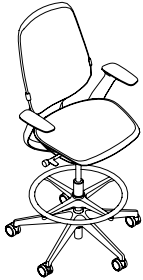

Tip: For more information regarding color schemes, see page 78.

Tip: Leather, vinyl, Customer's Own Material (COM), and Customer's Own Leather (COL) are not available on seat and back.

Tip: Frame finish matches color scheme unless Lux Coatings frame is selected.

Tip: If Lux Coatings frame is selected, arm frame and base will match.

Tip: Polished aluminum base and arms are not available if Lux Coatings is chosen for frame finish.

Tip: Soil-retardant treatment not available.

Tip: Hard casters are recommended for use on soft flooring (i.e., carpet). Soft casters are recommended for use on hard flooring (i.e., hardwood) to help prevent scuffs and damage.

Standard Includes		Required to Specify
<ul style="list-style-type: none"> ▶ Need help? Product details, page 74 	<ul style="list-style-type: none"> 8" pneumatic seat-height adjustment (21"-29") Passive seat edge angle Frame, seat shell, and five-arm plastic base: textured paint 4D arms, rectilinear, height-, width-, pivot-, and depth-adjustable arms Intermix price group 1 on seat and back 2½"-diameter, hard dual-wheeled casters: black 	<ol style="list-style-type: none"> 1 Style number 2 Color scheme (see below under Required Selections) 3 Intermix color for seat and back 4 Options, if selected (see below) <ul style="list-style-type: none"> ▶ See <i>Surface Materials</i>, page 634.

Required Selections	U.S. Price	Required to Specify
Color Scheme		
<ul style="list-style-type: none"> Black Merle Platinum Seagull 	<ul style="list-style-type: none"> No cost No cost No cost No cost 	<ul style="list-style-type: none"> Specify with 6205 Black. Specify with 7360 Merle. Specify with 7190 Platinum. Specify with 7243 Seagull.

Options	U.S. Price	Required to Specify
Surface Materials		
Intermix on seat and back		
<ul style="list-style-type: none"> Intermix price group 1 Intermix Shift price group 2 Intermix Opaque price group 3 	<ul style="list-style-type: none"> No cost +\$ 36 +\$ 68 	<ul style="list-style-type: none"> Specify Intermix color number. Specify Intermix Shift color number. Specify Intermix Opaque color number.
Rear frame		
<ul style="list-style-type: none"> Lux Coatings 	<ul style="list-style-type: none"> +\$ 49 	<ul style="list-style-type: none"> Specify Lux Coatings color number.
Base		
<ul style="list-style-type: none"> Lux Coatings Polished aluminum base 	<ul style="list-style-type: none"> +\$131 +\$186 	<ul style="list-style-type: none"> Specify Lux Coatings color number. Specify with polished aluminum base.
Arms		
<ul style="list-style-type: none"> Lux Coatings 	<ul style="list-style-type: none"> +\$ 85 	<ul style="list-style-type: none"> Specify Lux Coatings color number.
Arms		
<ul style="list-style-type: none"> Height-adjustable arms Fixed arms Armless Polished aluminum fixed arms 	<ul style="list-style-type: none"> -\$ 71 -\$144 -\$367 +\$100 	<ul style="list-style-type: none"> Specify with height-adjustable arms. Specify with fixed arms. Specify without arms. Specify with polished aluminum fixed arms.
Lumbar		
<ul style="list-style-type: none"> Adjustable lumbar support 	<ul style="list-style-type: none"> +\$ 93 	<ul style="list-style-type: none"> Specify with adjustable lumbar.
Casters		
<ul style="list-style-type: none"> Soft, dark grey treaded, dual-wheel roll-control casters for use on hard floors Hard, black interior/black treaded hubless casters for use on soft floors Soft, black interior/black treaded hubless casters, for use on hard floors 	<ul style="list-style-type: none"> +\$ 36 +\$140 +\$179 	<ul style="list-style-type: none"> Specify with soft casters. Specify with hard, hubless casters. Specify with soft, hubless casters.
Glides		
<ul style="list-style-type: none"> Glides: plastic 	<ul style="list-style-type: none"> +\$ 36 	<ul style="list-style-type: none"> Specify with glides.
Coat Hanger		
<ul style="list-style-type: none"> Field-installed coat hanger 	<ul style="list-style-type: none"> +\$ 45 	<ul style="list-style-type: none"> Specify with coat hanger.
CarbonNeutral Product		
<ul style="list-style-type: none"> CarbonNeutral product certification 	<ul style="list-style-type: none"> +\$ 35 	<ul style="list-style-type: none"> Add suffix CN to the end of the style number.

Specification Information	
Style Number	U.S. Base Price
419B000	\$1994

 **For Canadian Pricing**
 Multiply U.S. Price by the Canadian price factor.
 ▶ See page 1 for details.

Steelcase Karman

Steelcase Karman High-Back Work Chair with Intermix Performance Textile

High-Back with Performance Intermix on Seat and Back

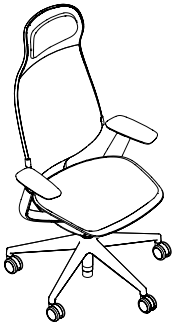

Tip: For more information regarding color schemes, see page 78.

Tip: Leather, vinyl, Customer's Own Material (COM), and Customer's Own Leather (COL) are not available on Steelcase Karman.

Tip: Rear frame, arm frame, and base finish matches color scheme unless Lux Coatings frame is selected.

Tip: If Lux Coatings is selected, rear frame, arm frame, and base will match.

Tip: Polished aluminum base and arms are not available if Lux Coatings is chosen for frame finish.

Tip: Intermix selection is applied on both seat and back and must be the same on both.

Tip: Neck support pillow follows intermix selection of the seat and back, and is field serviceable only on high-back chairs that were originally specified with a neck support pillow. Pillow is not able to be specified on existing Steelcase Karman chairs that did not originally have a neck support pillow.

Tip: Soil-retardant treatment not available.

Tip: Hard casters are recommended for use on soft flooring (i.e., carpet). Soft casters are recommended for use on hard flooring (i.e., hardwood) to help prevent scuffs and damage.



For Canadian Pricing

Multiply U.S. Price by the Canadian price factor.

► See page 1 for details.

Standard Includes		Required to Specify
-------------------	--	---------------------

► Need help? Product details, page 74	<ul style="list-style-type: none"> 5" pneumatic seat-height adjustment (16"–21") Passive seat edge angle Frame, seat shell, and five-arm plastic base: textured paint 4D arms, rectilinear, height-, width-, pivot-, and depth-adjustable arms High-back with adjustable neck support pillow Intermix price group 1 on seat, back, and neck support pillow 2½"-diameter, hard dual-wheeled casters: black 	<ol style="list-style-type: none"> Style number Color scheme (see below under Required Selections) Intermix color for seat and back Options, if selected (see below) <ul style="list-style-type: none"> ► See <i>Surface Materials</i>, page 634.
---------------------------------------	--	---

Required Selections	U.S. Price	Required to Specify
---------------------	------------	---------------------

Color Scheme	<ul style="list-style-type: none"> Black Platinum Seagull Merle 	<ul style="list-style-type: none"> No cost No cost No cost No cost 	<ul style="list-style-type: none"> Specify with 6205 Black. Specify with 7190 Platinum. Specify with 7243 Seagull. Specify with 7360 Merle.
---------------------	---	--	---

Options	U.S. Price	Required to Specify
---------	------------	---------------------

Surface Materials	Intermix on seat, back, and neck support pillow		
	<ul style="list-style-type: none"> Intermix price group 1 Intermix Shift price group 2 Intermix Opaque price group 3 	<ul style="list-style-type: none"> No cost +\$ 36 +\$ 68 	<ul style="list-style-type: none"> Specify Intermix color number. Specify Intermix Shift color number. Specify Intermix Opaque color number.
	Rear frame		
	<ul style="list-style-type: none"> Lux Coatings 	<ul style="list-style-type: none"> +\$ 49 	<ul style="list-style-type: none"> Specify Lux Coatings color number.
	Base		
	<ul style="list-style-type: none"> Lux Coatings Polished aluminum base 	<ul style="list-style-type: none"> +\$131 +\$186 	<ul style="list-style-type: none"> Specify Lux Coatings color number. Specify with polished aluminum base.
	Arms		
	<ul style="list-style-type: none"> Lux Coatings 	<ul style="list-style-type: none"> +\$ 85 	<ul style="list-style-type: none"> Specify Lux Coatings color number.
Arms	<ul style="list-style-type: none"> Height-adjustable arms Fixed arms Armless Polished aluminum fixed arms 	<ul style="list-style-type: none"> –\$ 71 –\$144 –\$367 +\$100 	<ul style="list-style-type: none"> Specify with height-adjustable arms. Specify with fixed arms. Specify without arms. Specify with polished aluminum fixed arms.
Lumbar	<ul style="list-style-type: none"> Adjustable lumbar support 	<ul style="list-style-type: none"> +\$ 93 	<ul style="list-style-type: none"> Specify with adjustable lumbar.
Seat Height	<ul style="list-style-type: none"> 4" low-range pneumatic seat-height adjustment (14"–18") 7" high-range pneumatic seat-height adjustment (20"–27") 	<ul style="list-style-type: none"> +\$ 82 +\$ 82 	<ul style="list-style-type: none"> Specify with low-range cylinder. Specify with high-range cylinder.
Casters	<ul style="list-style-type: none"> Soft, dark grey treaded, dual-wheel roll-control casters for use on hard floors Hard, black interior/black treaded hubless casters for use on soft floors Soft, black interior/black treaded hubless casters, for use on hard floors 	<ul style="list-style-type: none"> +\$ 36 +\$140 +\$179 	<ul style="list-style-type: none"> Specify with soft casters. Specify with hard, hubless casters. Specify with soft, hubless casters.
Glides	<ul style="list-style-type: none"> Glides: plastic 	<ul style="list-style-type: none"> +\$ 36 	<ul style="list-style-type: none"> Specify with glides.
Coat Hanger	<ul style="list-style-type: none"> Field-installed coat hanger 	<ul style="list-style-type: none"> +\$ 45 	<ul style="list-style-type: none"> Specify with coat hanger.
Neck Support Pillow	<ul style="list-style-type: none"> No neck support pillow 	<ul style="list-style-type: none"> –\$ 50 	<ul style="list-style-type: none"> Specify with no neck support pillow.
CarbonNeutral Product	<ul style="list-style-type: none"> CarbonNeutral product certification 	<ul style="list-style-type: none"> +\$ 35 	<ul style="list-style-type: none"> Add suffix CN to the end of the style number.

Specification Information

Style Number	U.S. Base Price
419A500	\$2044

Steelcase Karman Lumbar



Tip: Lumbar is retrofittable and applicable on all chair and stool styles.

Tip: Stand alone add on accessories are not available with CarbonNeutral product certification.

Standard Includes		Required to Specify
▶ Need help? Product details, page 74	• Adjustable lumbar	1 Style number 2 Color scheme (see below under Required Selections)

Color Scheme	Required Selections	U.S. Price	Required to Specify
	• Black	No cost	Specify with 6205 Black.
	• Merle	No cost	Specify with 7360 Merle.
	• Platinum	No cost	Specify with 7190 Platinum.
	• Seagull	No cost	Specify with 7243 Seagull.

Specification Information	
Style Number	U.S. Price
419LUMBAR	\$93

Steelcase Karman Coat Hanger

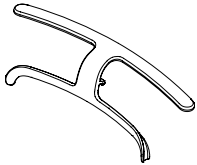

Tip: Coat hanger is retrofittable and applicable on all chair and stool styles.

Tip: Stand alone add on accessories are not available with CarbonNeutral product certification.

Standard Includes		Required to Specify
▶ Need help? Product details, page 74	• Field-installed coat hanger	1 Style number 2 Color scheme (see below under Required Selections)

Color Scheme	Required Selections	U.S. Price	Required to Specify
	• Sterling dark	No cost	Specify with 6059 Sterling Dark.
	• Black	No cost	Specify with 6205 Black.

Specification Information	
Style Number	U.S. Price
419COATHANGER	\$65

 **For Canadian Pricing**
Multiply U.S. Price by the Canadian price factor.
▶ See page 1 for details.

