

vanEsch

THE PERFECT ENTRANCE

De Projectinrichter 

www.deprojectinrichter.com

088 - 650 12 34

THE PERFECT ENTRANCE

INHOUD INDEX INHALT CONTENT

AQUARIUS H	193
AQUARIUS S	221
CHASE	115
CIRCUS	257
CORNER GUY	123
DODICI DRIP QUATTRO SEI	129
FOLDR	159
LISTON	165
OCLOCK	243
PICTOR	177
PRIMA VISTA	147
SILO	171
SIX PACK	153
SLIDE	281
SOFT TABLES	249
SPRING	103
STICKS	271
TERTIO BENCHES	053
TERTIO COAT RACKS	007
TORO	075
TREE HOOKED	265
TUBULUS	083
WINGS	139
REFERENCE RIJKSMUSEUM	291
REFERENCE BERNHOVEN	297
REFERENCE BUREAU JEUGDZORG	301
REFERENCE INDICIA	307
REFERENCE RABOBANK	311
REFERENCE EUROMEX	319
REFERENCE LIST	323



vanEsch SPECIALIST

VAN ESCH, ESTABLISHED IN 1972

Regardless of whether located in a business premises or in a home, the entrance of a building says a great deal about the people who use it. It is quite striking how over the last few years the differences between the two have become increasingly smaller. Elements of the home can now be found on the work floor and vice versa. The reason is that everyone simply wants to look their best.

This development can also be seen in the history of van Esch, a family business that is specialised in the production of cloakroom systems and entrance area accessories. In 1972 Hendrik Jan Willem van Esch started working in his basement in Rijswijk on the production of cloakroom systems. Designer Gerard Kerklaan (*1941-†2003) not only put together the programme, but he also came up with the visual identity. This do-it-yourself mentality characterised the company long into the nineteen eighties.

But the market changed and, therefore, so did the company, which now operates from Goirle. Ad and Simon van Esch, who took charge of the company in 1988, broadened their outlook. They started working with various designers who gave a new impulse to the collection. Initially this was practically all produced in-house. These days some of the production is outsourced to top quality specialists.

Presentation, storage and reception; these are the three cornerstones of van Esch. After all, being well received gives one a sense of being immediately welcome. The layout of the entrance plays an important role in this. It is the place where a person or company presents himself; a calling card as it were. It is also the place where visitors leave their coats and bags.

For every entrance or reception area van Esch provides a suitable solution. In its designs the company works exclusively with experienced and talented designers from home and abroad. They have an excellent feel for the market and can constantly adapt the collection according to the wishes of the time. Made-to-measure solutions is one of the specialisations of van Esch that allows it to collaborate effectively with interior architects.

The Perfect Entrance collection consists of high-quality products for reception areas; from cloakroom systems to brochure stands, and from mirrors to lockers. The timeless designs are not only suitable for offices, hospitals, museums and hotels, but also for the home. All products are sold through a network of selected dealers.

TERTIO KAPSTOKKEN COAT RACKS GARDEROBEN PORTEMANTEAUX

design Gerard Kerklaan (*1941-†2003), The Netherlands



TERTIO

KAPSTOKKEN

Tertio is het antwoord op de vraag naar mooi vormgegeven garderobesystemen voor de projectinrichting. Het door de Nederlandse designer Gerard Kerklaan ontworpen systeem is niet alleen functioneel en representatief, maar heeft ook een vriendelijke uitstraling. Het programma is dermate uitgebreid dat voor ieder probleem een oplossing te vinden is. De veelzijdigheid van Tertio maakt maatwerk bovendien mogelijk.

COAT RACKS

Tertio is the answer to the demand for attractively designed cloakroom systems for project design. This system designed by Dutch designer Gerard Kerklaan is not only functional and attractive, but it also gives a welcoming feel. The comprehensive programme is such that a solution can be found to any problem. What's more, the versatility of Tertio allows for tailor-made solutions.

GARDEROBEN

Tertio – die Antwort auf den Bedarf an visuell ansprechend gestalteten Garderobensystemen für Projekteinrichtungen. Das von dem niederländischen Designer Gerard Kerklaan entworfene System überzeugt nicht nur durch Funktionsfülle und repräsentative Optik, sondern auch wegen seiner freundlichen Ausstrahlung. Das breit gefächerte und vielseitige Programm bietet für jedes Problem passende und auch maßgeschneiderte Lösungen.

PORTEMANTEAUX

Tertio répond à la demande en équipements de vestiaires, d'aspect agréable et destinés aux réalisations professionnelles. Cette gamme, créée par le designer néerlandais Gerard Kerklaan, n'est pas seulement fonctionnelle et représentative, elle a aussi un aspect attrayant. Elle est tellement complète qu'elle offre une solution à chaque problème. Avec sa diversité, Tertio permet en outre de réaliser des équipements sur mesure.





010 VAN ESCH



011 VAN ESCH







016 VAN ESCH

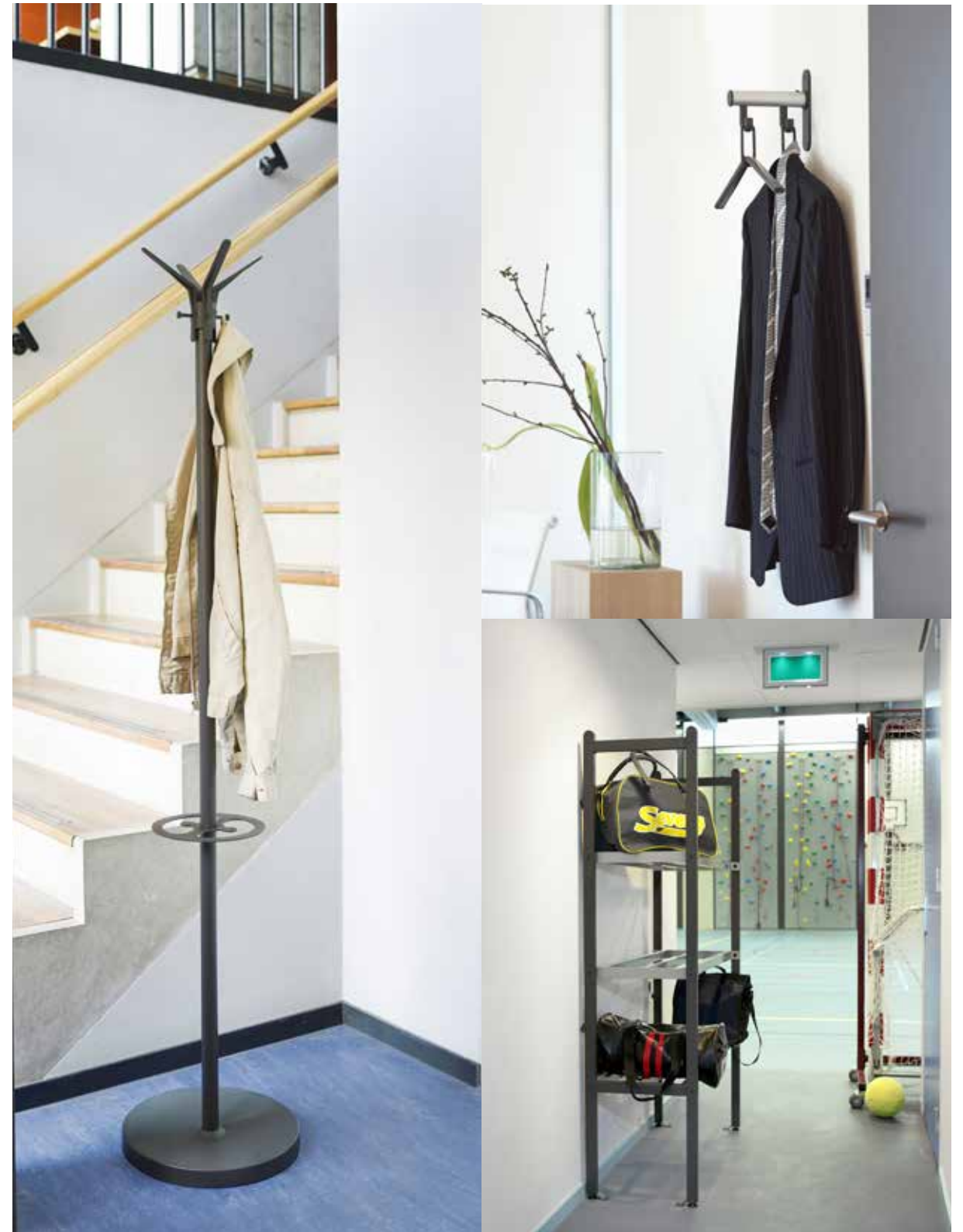

017 VAN ESCH





TERTIO EVKP

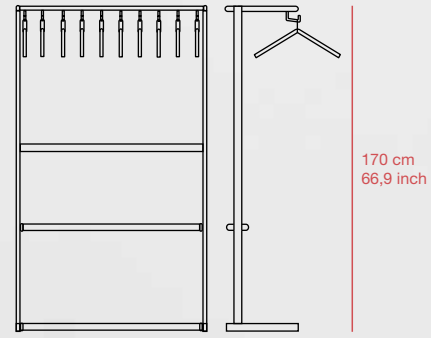

100 cm
39,4 inch

60 cm
23,6 inch

170 cm
66,9 inch

Supports



vE 7377

Profiles

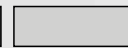

Aluminium



RAL 3002



RAL 5002

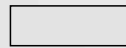

RAL 9006

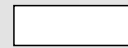

RAL 9010



RAL 9011



TERTIO EVK

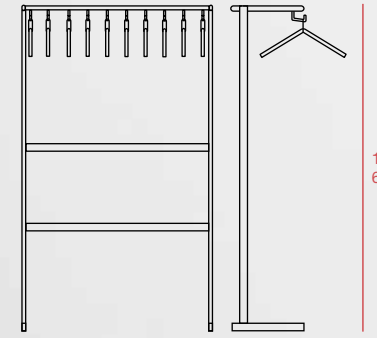

100 cm
39,4 inch

60 cm
23,6 inch

170 cm
66,9 inch

Supports

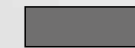

vE 7377

Profiles

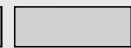

Aluminium



RAL 3002



RAL 5002



RAL 9006



RAL 9010



RAL 9011



TERTIO EV2P



100 cm
39,4 inch

41 cm
16,1 inch

170 cm
66,9 inch

Supports

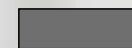

vE 7377

Profiles

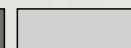

Aluminium



RAL 3002

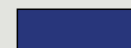

RAL 5002

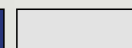

RAL 9006



RAL 9010



RAL 9011



TERTIO EV2

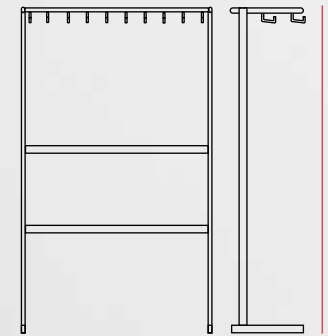

100 cm
39,4 inch

41 cm
16,1 inch

170 cm
66,9 inch

Supports

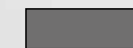

vE 7377

Profiles



Aluminium



RAL 3002

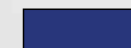

RAL 5002



RAL 9006



RAL 9010



RAL 9011

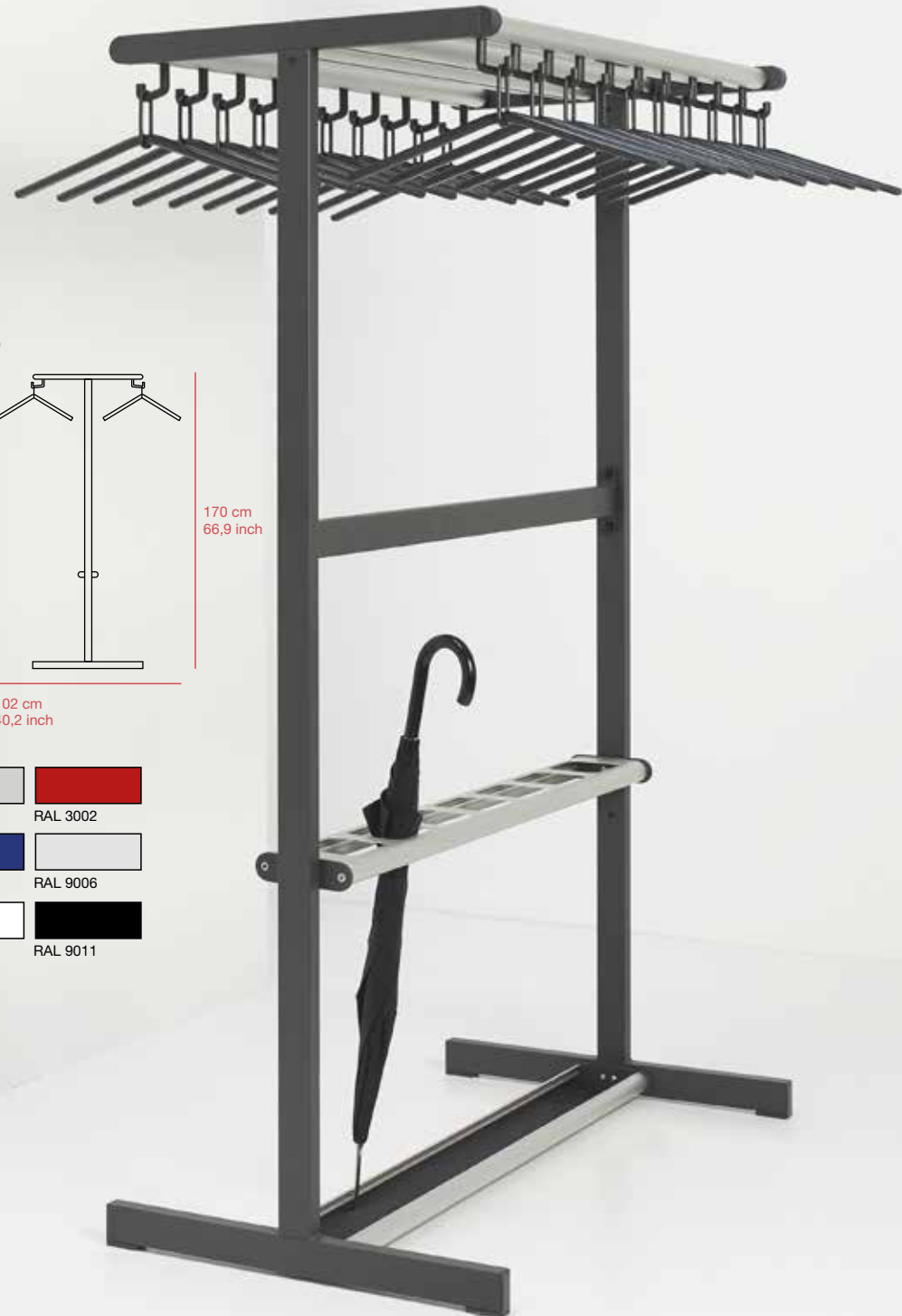

TERTIO DVKP

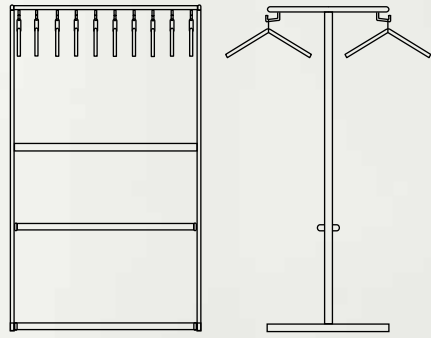

170 cm
66,9 inch

100 cm
39,4 inch

102 cm
40,2 inch

Supports



vE 7377

Profiles



Aluminium



RAL 3002

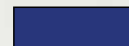

RAL 5002

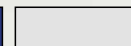

RAL 9006



RAL 9010



RAL 9011



TERTIO DVK

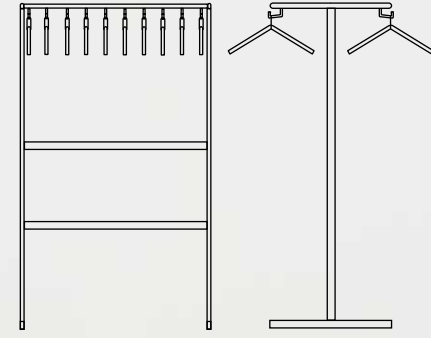

170 cm
66,9 inch

100 cm
39,4 inch

102 cm
40,2 inch

Supports



vE 7377

Profiles



Aluminium



RAL 3002

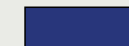

RAL 5002

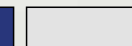

RAL 9006



RAL 9010



RAL 9011

TERTIO DV2P

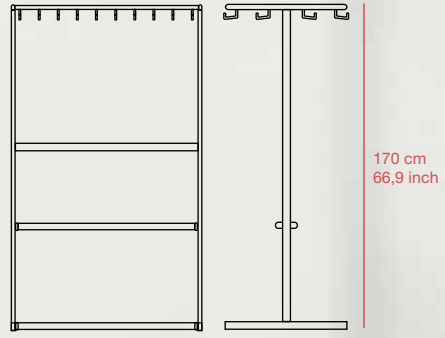

100 cm
39,4 inch

60 cm
23,6 inch

170 cm
66,9 inch

Supports

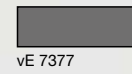

vE 7377

Profiles



Aluminium

RAL 3002

RAL 5002

RAL 9006

RAL 9010

RAL 9011

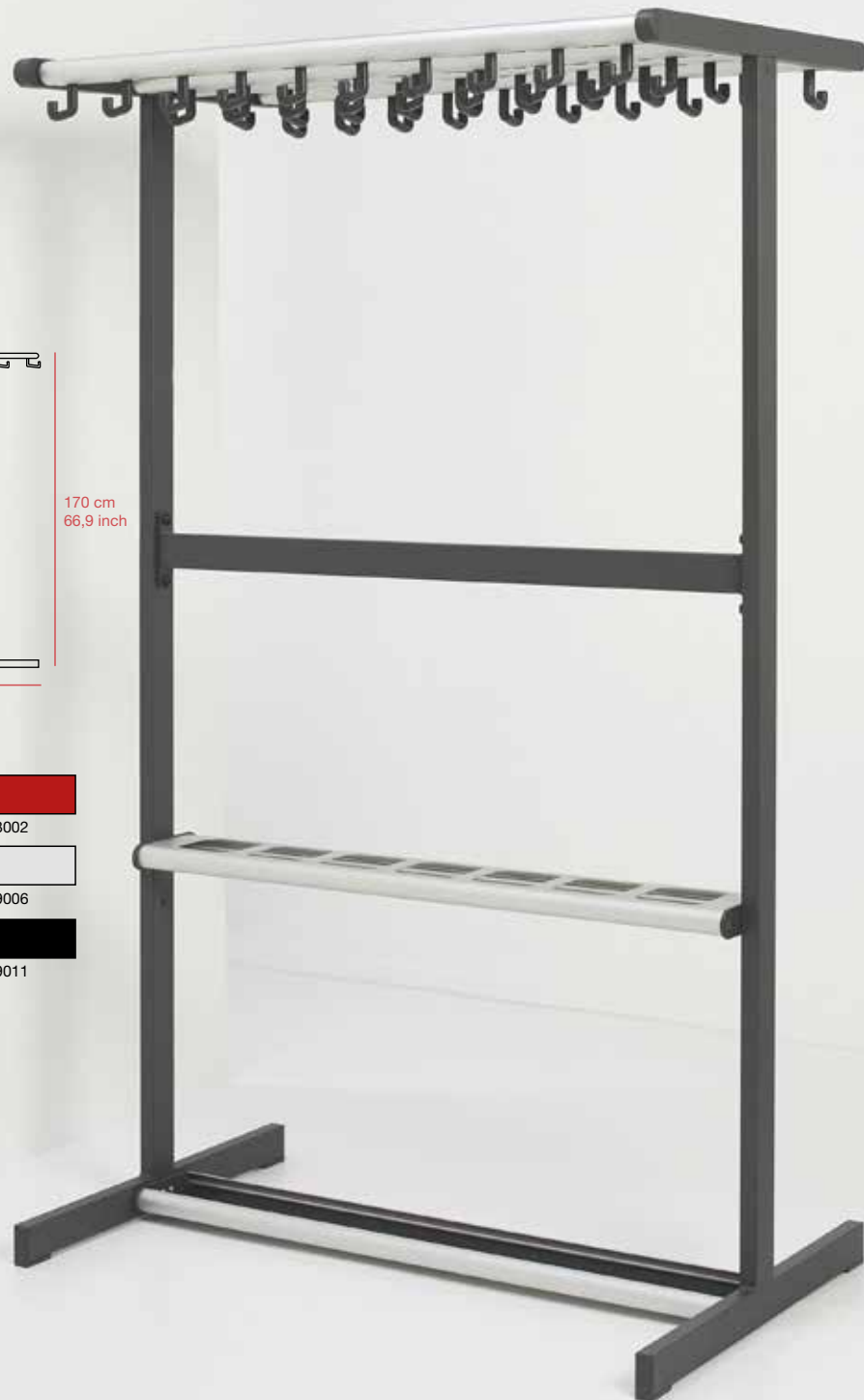

TERTIO DV2

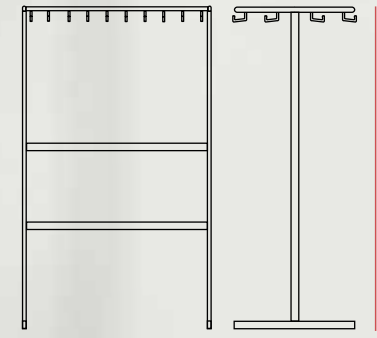

100 cm
39,4 inch

60 cm
23,6 inch

170 cm
66,9 inch

Supports

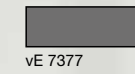

vE 7377

Profiles

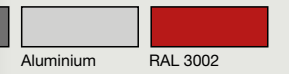

Aluminium

RAL 3002

RAL 5002

RAL 9006

RAL 9010

RAL 9011



TERTIO P70

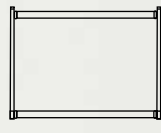

70 cm
27,6 inch

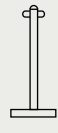

53 cm
20,9 inch

Supports



vE 7377

Profiles



Aluminium



TERTIO P100

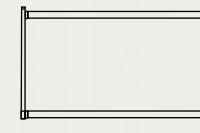

100 cm
39,4 inch



53 cm
20,9 inch

22 cm
8,7 inch

Supports



vE 7377

Profiles



Aluminium



TERTIO JUNIOR

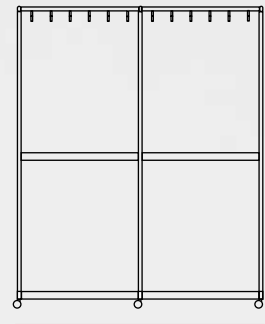

120 cm / 150 cm
47,2 inch / 59,1 inch

160 cm
63,0 inch

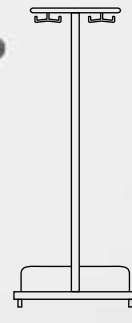

120 cm / 150 cm
47,2 inch / 59,1 inch

60 cm
23,6 inch

Supports

Profiles

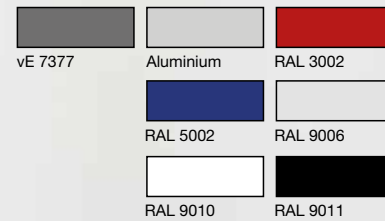

TERTIO TR3

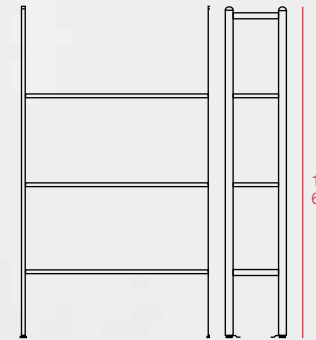

170 cm
66,9 inch

100 cm
39,4 inch

42,5 cm
16,7 inch

Supports

Profiles



vE 7377

RAL 9006



TERTIO JUNO+



168 cm
66,1 inch



35 cm
13,8 inch



VE 9310



VE 9306



VE 7377



VE 9311



TERTIO JUPITER+

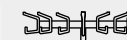

174 cm
68,5 inch

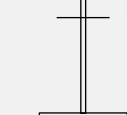

45 cm
17,7 inch

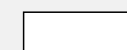

VE 9310



VE 9306



VE 7377



VE 9311



TERTIO SAGITTA+



170 cm
66,9 inch

45 cm
17,7 inch

Profiles



Aluminium

Column, Umbrella holder, Base

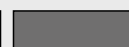

VE 7377



VE 9306



VE 9311

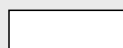

VE 9310



TERTIO PALADINO+

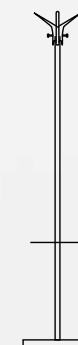

174 cm
68,5 inch

35 cm
13,8 inch

Profiles



VE 7377



TERTIO WK

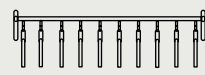

30 cm
11,8 inch

100 cm
39,4 inch

54 cm
21,3 inch

Supports

Profiles



vE 7377

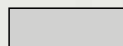

Aluminium



RAL 3002

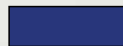

RAL 5002



RAL 9006



RAL 9010



RAL 9011



TERTIO W2



16 cm
6,3 inch

100 cm
39,4 inch

33 cm
13,0 inch

Supports

Profiles



vE 7377

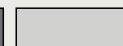

Aluminium



RAL 3002

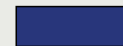

RAL 5002



RAL 9006

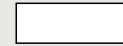

RAL 9010



RAL 9011



TERTIO HI0K



10 cm
3,9 inch

Supports

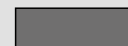

vE 7377

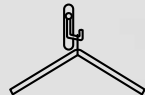

45 cm
17,7 inch

Profiles

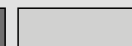

Aluminium

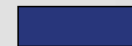

RAL 5002



RAL 9010



RAL 3002



RAL 9006

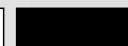

RAL 9011

30 cm
11,8 inch



TERTIO HI6K



16 cm
6,3 inch

Supports



vE 7377



45 cm
17,7 inch

Profiles

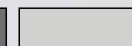

Aluminium

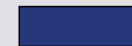

RAL 5002



RAL 9010



RAL 3002



RAL 9006



RAL 9011

30 cm
11,8 inch



TERTIO H22K



22 cm
8,7 inch

Supports



vE 7377



45 cm
17,7 inch

Profiles

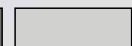

Aluminium

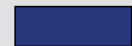

RAL 5002



RAL 9010



RAL 3002



RAL 9006



RAL 9011

30 cm
11,8 inch



TERTIO H28K

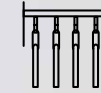

28 cm
11 inch

Supports

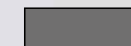

vE 7377



45 cm
17,7 inch

Profiles

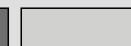

Aluminium

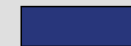

RAL 5002



RAL 9010



RAL 3002



RAL 9006



RAL 9011

30 cm
11,8 inch



TERTIO H

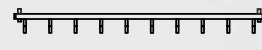

100 cm
39,4 inch

Supports

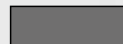

VE 7377

Profiles

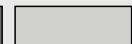

Aluminium



RAL 3002



RAL 5002

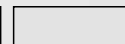

RAL 9006

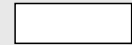

RAL 9010



RAL 9011



8 cm
3,1 inch

8 cm
3,1 inch



TERTIO HI

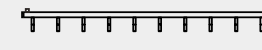

100 cm
39,4 inch

Supports



VE 7377

Profiles

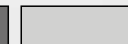

Aluminium



RAL 3002



RAL 5002

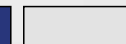

RAL 9006

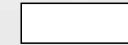

RAL 9010



RAL 9011



8 cm
3,1 inch

8 cm
3,1 inch



TERTIO HA



16 cm
6,3 inch

100 cm
39,4 inch

15 cm
5,9 inch

Supports



VE 7377

Profiles

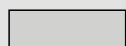

Aluminium



RAL 3002

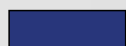

RAL 5002

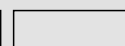

RAL 9006



RAL 9010

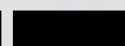

RAL 9011



TERTIO HD



16 cm
6,3 inch

100 cm
39,4 inch

15 cm
5,9 inch

Supports



VE 7377

Profiles



Aluminium



RAL 3002

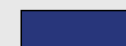

RAL 5002

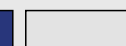

RAL 9006

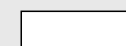

RAL 9010



RAL 9011



TERTIO HJH

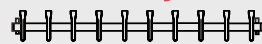

100 cm
39,4 inch

12 cm
4,7 inch

Supports

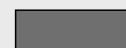

vE 7377

Profiles



Aluminium



RAL 3002

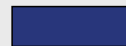

RAL 5002



RAL 9006

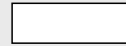

RAL 9010



RAL 9011



TERTIO H40 MAGNÉFIQUE

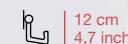

40 cm
15,7 inch

5 cm
2,0 inch

Magnets

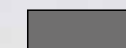

Dark grey

Profiles

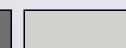

Aluminium



RAL 3002



RAL 5002



RAL 9006



RAL 9010



RAL 9011



TERTIO H MAGNÉFIQUE

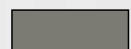
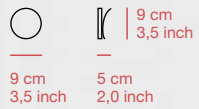

Dark grey



TERTIO H37 MAGNÉFIQUE



37 cm
14,6 inch

5,5 cm
2,2 inch

Coat hooks

Profile



Dark grey

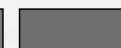

vE 7377

TERTIO COAT RACKS ACCESSORIES



Anti-theft mounting eye



Number tags



Floor mounting fittings



Castor wheel

TERTIO BANKEN BENCHES BÄNKE BANCS

design Gerard Kerklaan (*1941-†2003), The Netherlands



TERTIO

BANKEN

Binnen het Tertio programma nemen de banken een bijzondere plaats in. Niet alleen omdat ze door hun open karakter vriendelijk aandoen, maar ook door de vele mogelijkheden. Zo is er naast een vrijstaand exemplaar ook een wandbank verkrijgbaar, met of zonder schoenenrek. De zitting is verkrijgbaar in blank gelakt grenen of witte kunststof. Standaard zijn ze leverbaar tot een lengte van 3 meter. Door verschillende functies toe te voegen verandert de bank in een garderobebank. Ook die kan vrij in de ruimte of tegen de muur worden geplaatst.

BENCHES

Benches have a very special place in the Tertio series. Not only because their open character makes them look so inviting, but also due to the many possibilities they offer. For example, in addition to a freestanding model the series also includes a wall bench, with or without a shoe rack. The seat is available in clear varnished pinewood or white plastic. As standard they come up to a length of 3 metres. By adding various functions the bench changes into a cloakroom bench. This can also be placed freestanding in the middle of a room or against the wall.

BÄNKE

Innerhalb des Programms Tertio nehmen die Bänke einen besonderen Platz ein. Nicht nur aufgrund ihrer freundlichen Ausstrahlung, sondern auch wegen ihrer funktionellen Vielseitigkeit. Neben einem freistehenden Modell ist auch eine Wandbank erhältlich, je nach Wunsch mit oder ohne Schuhrost. Die Sitzfläche ist aus farblos lackiertem Kiefernholz oder mit weißer Kunststoffbekleidung erhältlich. Sie sind serienmäßig bis zu einer Länge von 3 Metern lieferbar. Werden weitere Funktionen hinzugefügt, verwandelt sich die vielseitige Bank in eine Garderobebank. Diese kann ebenfalls frei im Raum oder entlang einer Wand aufgestellt werden.

BANCS

Les bancs occupent une place particulière dans la gamme Tertio. Non seulement en raison de leur caractère avenant, mais aussi du fait des nombreuses possibilités qu'ils offrent. Ainsi, outre un exemplaire à placer librement, un banc mural est également disponible, avec ou sans étagère à chaussures. Le siège est disponible en pin laqué naturel ou en matière synthétique blanche. Ces bancs sont disponibles en modèles standard dans une longueur pouvant atteindre 3 mètres. L'ajout de différentes fonctions permet de transformer le banc en banc de vestiaires. Il peut aussi être placé librement dans une pièce ou contre un mur.





TERTIO BEVS+

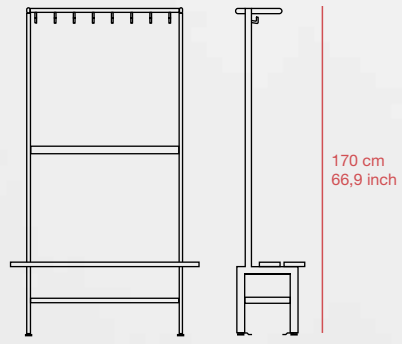

100 cm
39,4 inch

44 cm
17,3 inch

Supports

Profiles

Seat parts

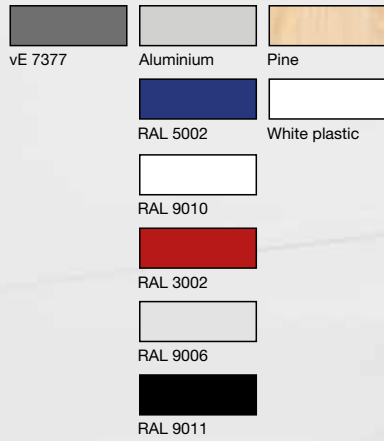

TERTIO BEV+

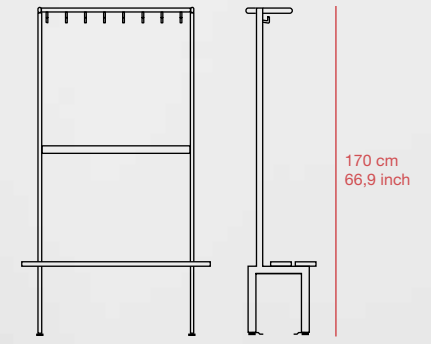

100 cm
39,4 inch

44 cm
17,3 inch

Supports

Profiles

Seat parts

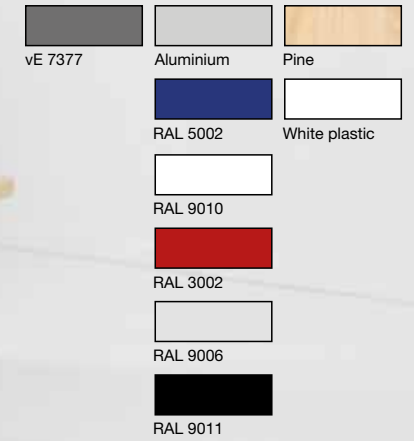

TERTIO BEVS

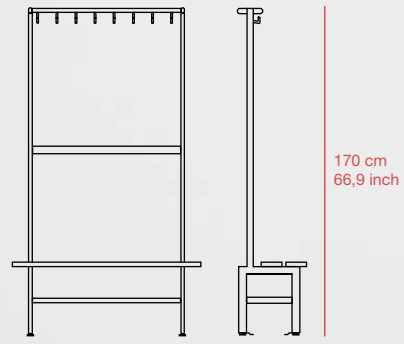

100 cm
39,4 inch

44 cm
17,3 inch

Supports Profiles Seat parts

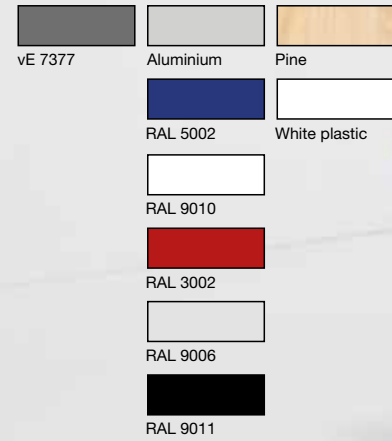

See reference page 311

TERTIO BEV

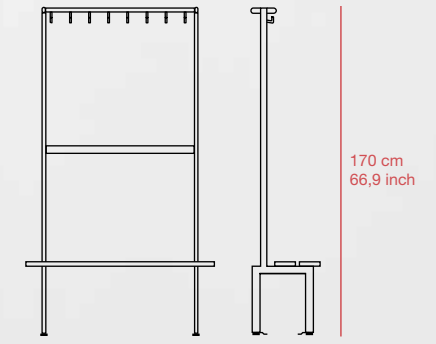

100 cm
39,4 inch

44 cm
17,3 inch

Supports Profiles Seat parts



TERTIO BDVS+

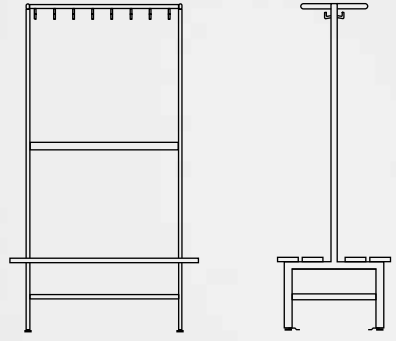

170 cm
66,9 inch

100 cm
39,4 inch

Supports

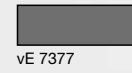

vE 7377

Profiles

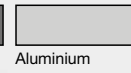

Aluminium

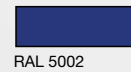

RAL 5002

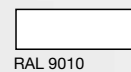

RAL 9010



RAL 3002

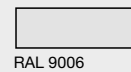

RAL 9006

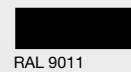

RAL 9011

76 cm
30,0 inch

Seat parts



Pine

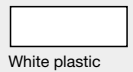

White plastic

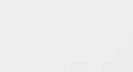

RAL 9010



RAL 3002

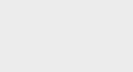

RAL 9006

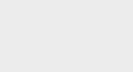

RAL 9011



TERTIO BDV+

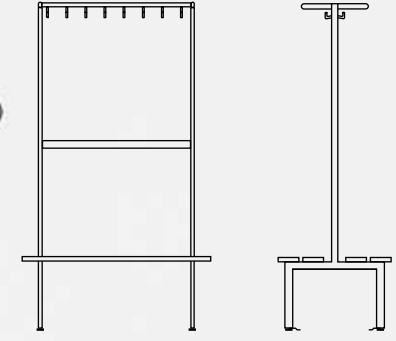

170 cm
66,9 inch

100 cm
39,4 inch

Supports

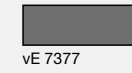

vE 7377

Profiles

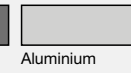

Aluminium

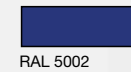

RAL 5002

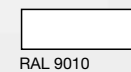

RAL 9010



RAL 3002

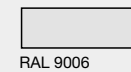

RAL 9006

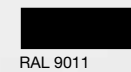

RAL 9011

76 cm
30,0 inch

Seat parts



Pine

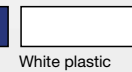

White plastic

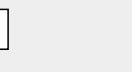

RAL 9010

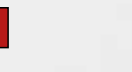

RAL 3002

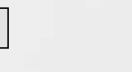

RAL 9006

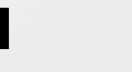

RAL 9011



See reference page 311

TERTIO BVS



44 cm
17,3 inch

100 cm
39,4 inch

38 cm
15,0 inch

Supports



vE 7377

Profiles



Aluminium



RAL 5002



RAL 9010



RAL 3002

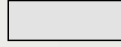

RAL 9006



RAL 9011

Seat parts



Pine



White plastic



TERTIO BV



44 cm
17,3 inch

100 cm
39,4 inch

38 cm
15,0 inch

Supports



vE 7377

Seat parts



Pine



White plastic



TERTIO BEWS+

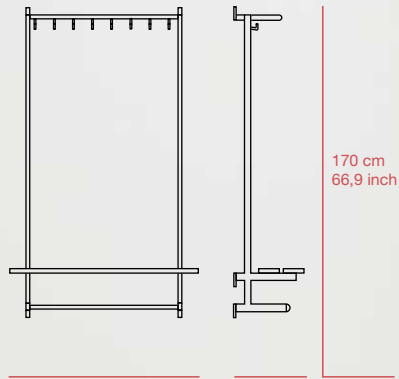

100 cm
39,4 inch

44 cm
17,3 inch

Supports

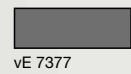

vE 7377

Profiles

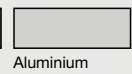

Aluminium

Seat parts



Pine

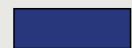

RAL 5002

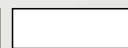

White plastic



RAL 9010



RAL 3002



RAL 9006



RAL 9011



TERTIO BEW+

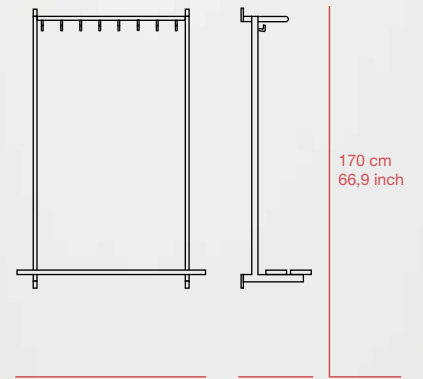

100 cm
39,4 inch

44 cm
17,3 inch

Supports

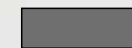

vE 7377

Profiles

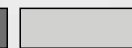

Aluminium

Seat parts



Pine

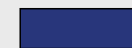

RAL 5002



White plastic

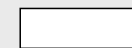

RAL 9010



RAL 3002

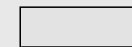

RAL 9006

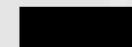

RAL 9011



TERTIO BEWS

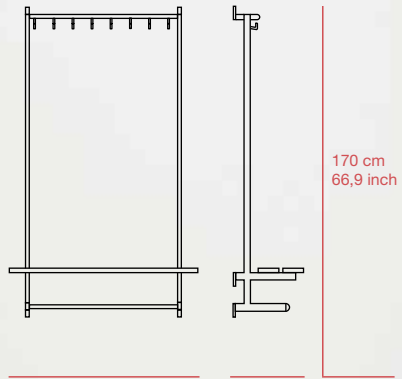

100 cm
39,4 inch

44 cm
17,3 inch

Supports

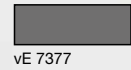

vE 7377

Profiles

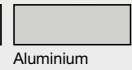

Aluminium



RAL 5002

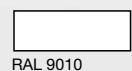

RAL 9010



RAL 3002

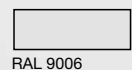

RAL 9006

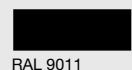

RAL 9011

Seat parts



Pine

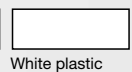

White plastic

170 cm
66,9 inch



TERTIO BEW

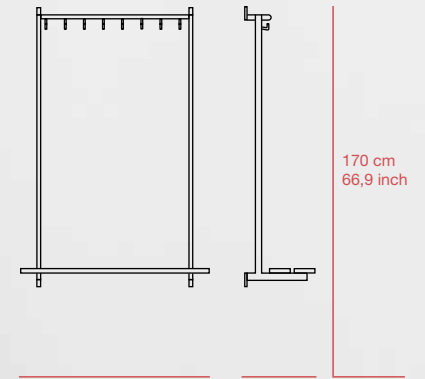

100 cm
39,4 inch

44 cm
17,3 inch

Supports

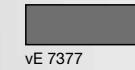

vE 7377

Profiles

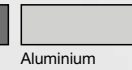

Aluminium

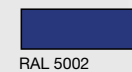

RAL 5002

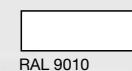

RAL 9010

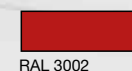

RAL 3002

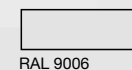

RAL 9006

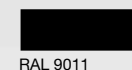

RAL 9011

Seat parts



Pine

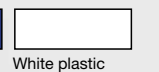

White plastic

170 cm
66,9 inch



TERTIO BWS

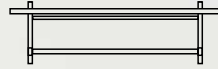

28 cm
11,0 inch

100 cm
39,4 inch

40 cm
15,7 inch

Supports



vE 7377

Profiles



Aluminium



RAL 5002

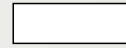

RAL 9010



RAL 3002

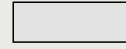

RAL 9006



RAL 9011

Seat parts



Pine



White plastic



TERTIO BW

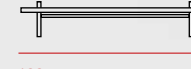

28 cm
11,0 inch

100 cm
39,4 inch

40 cm
15,7 inch

Supports



vE 7377

Seat parts



Pine

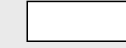

White plastic





TERTIO 20H



18 cm
7,1 inch

35 cm
13,8 inch

45 cm
17,7 inch

Supports

Seat parts



vE 7377

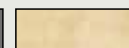

Birch

vanEsch

TORO

design Neal Hollis & Axis Design Europe, England



TORO

Een bijzondere garderobestandaard of brochurehouder. Het zijn dergelijke accessoires die sfeer brengen in een entree, kantoor of wachtruimte. Het programma Toro bestaat uit twee verschillende elementen waarvan de vormgeving op elkaar is afgestemd. Ze zijn ontworpen door Neal Hollis en het Engelse bureau Axis Design. Kenmerkend is het sierlijke ontwerp met speelse, functionele accenten. Zo contrasteren de blank gelakte beukenhouten knoppen van de garderobestandaard met de geëpoxeerde stalen buizen en ring. Aan Toro W kunnen verschillende verstelbare legborden worden bevestigd. Standaard worden er drie meegeleverd.

A unique looking coat stand or brochure holder. It is these sorts of accessories that add a certain ambiance to an entrance hall, office or waiting room. The Toro series consists of two different matching designs. They have been designed by Neal Hollis and the English bureau Axis Design. The distinctive design combines elegance with whimsical yet functional accents. In this way the knobs of clear varnished beech wood contrast with the tubes and ring made of epoxy coated steel. Various adjustable brochure holders can be attached to the Toro W. Three are supplied as standard.

Garderobenstände oder Broschürenhalter in einem. Es sind gerade solche Einrichtungsaccessoires, die Eingangsbereichen, Büroräumen oder Wartezimmern ihr besonderes Ambiente verleihen. Das Toro-Programm besteht aus zwei verschiedenen, aufeinander abgestimmten Design-Elementen. Die Entwürfe stammen von Neal Hollis und der britischen Agentur Axis Design. Das unverwechselbare Design kombiniert Eleganz mit verspielten und funktionellen Akzenten. Die farblos lackierten Buchholzknöpfe bilden einen interessanten Kontrast zu den Rohren und dem Ring aus epoxiertem Stahl. An Toro W können verschiedene verstellbare Halterungen befestigt werden. Serienmäßig werden drei Halterungen mitgeliefert.

Un portemanteau ou un présentoir mural. Ce sont là des accessoires qui agrémentent une entrée, un bureau ou une salle d'attente. La gamme Toro est constituée de deux éléments différents, au design assorti. Ils ont été conçus par Neal Hollis et le bureau anglais Axis Design. Ils se caractérisent par leur aspect élégant, aux accents fonctionnels, ludiques. Ainsi, les capuchons en bois de hêtre revêtu de laque transparente du portemanteau de vestiaires contrastent avec les tubes et l'anneau en acier à revêtement époxyde. Diverses étagères réglables peuvent être ajoutées à Toro W. Trois étagères sont fournies de façon standard.

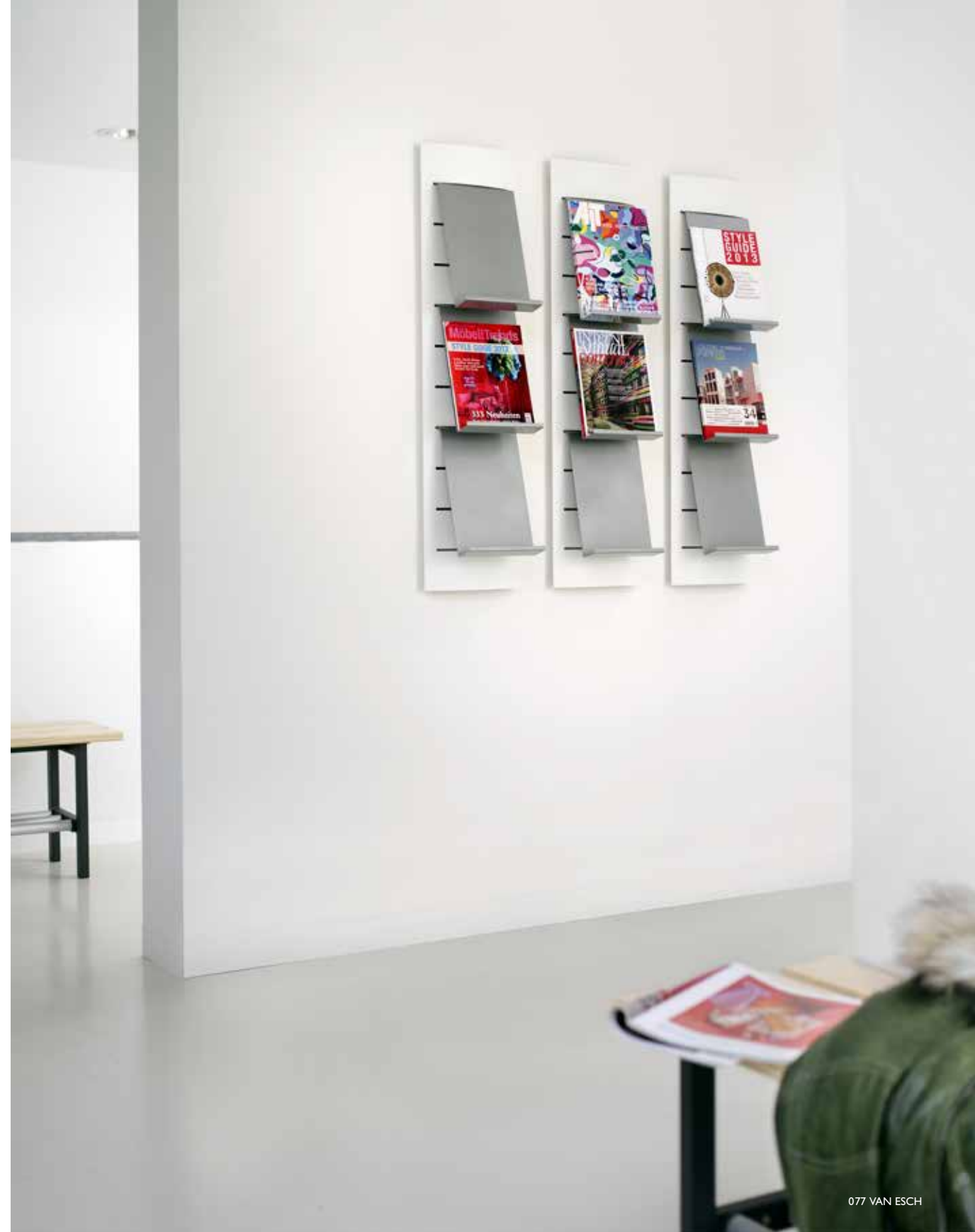



TORO G

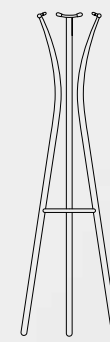

172 cm
67,7 inch

50 cm
19,7 inch

Tubes and ring **Knobs**



vE7377

Beech



vE 9306

Aluminium



vE 9310



vE 9311

TORO G+



172 cm
67.7 inch

50 cm
19.7 inch

Tubes and ring Knobs



vE 7377

Beech



vE 9306

Aluminium



vE 9310



vE 9311



TORO W



110 cm
43.3 inch

29 cm
11.4 inch

20 cm
7.9 inch

Frame

Brochure holders



vE 7377

RAL 9006

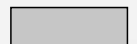

vE 9306

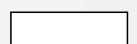

vE 9310



vE 9311



vanEsch
TUBULUS

design Maxime Szyf, Belgium,
Gerard Kerklaan (*1941- †2003) & van Esch Team,
The Netherlands



TUBULUS

Tubulus is een veelzijdig programma. De afzonderlijke producten combineren zakelijk, geborsteld en gepolijst roestvast staal met warm blank gelakt beuken. Bovendien verbinden zij strakke met ronde vormen. Dat maakt de serie bij uitstek geschikt voor zowel zakelijk als privé gebruik. Mooi in elke hal of kamer. Maxime Szyf en Gerard Kerklaan ontwierpen jashaken met en zonder kleerhanger, een wandkapstok, een bijzettafel, een buis voor kleerhangers met zowel plafond- als wandbevestiging, en kleerhangers. Los van elkaar te koop, maar ook uitstekend onderling te combineren.

Tubulus is a versatile programme. The individual products combine professional brushed and polished stainless steel with warm varnished beechwood. They also combine straight shapes with round shapes. This makes the series eminently suited for both business and private use. It will look great in every hallway or room. Maxime Szyf and Gerard Kerklaan designed clothes hooks with and without hanger, a wall-mount coat rack, a side table, a tube for both ceiling and wall-mount application and coat hangers. All elements are separately available and can be combined excellently.

Tubulus ist ein vielseitiges Programm. Die einzelnen Produkte kombinieren sachlichen, gebürsteten und polierten Edelstahl mit warmer transparent gelackter Buche. Und sie verbinden gerade mit runden Formen. Dadurch eignet sich die Serie gleichermaßen hervorragend für den geschäftlichen wie den privaten Bereich. Hübsch in jeder Eingangshalle.

Maxime Szyf und Gerard Kerklaan entwarfen Jackenhaken mit und ohne Bügel, eine Wandgarderobe, ein Beistelltisch, ein Rohr für Bügel mit Decken oder Wandbefestigung, und Kleiderbügel. Alle Teile sind einzeln erhältlich, lassen sich aber auch hervorragend miteinander kombinieren.

Tubulus est un programme varié. Les divers produits combinent la sobriété de l'acier inoxydable poli et brossé et la chaleur du hêtre laqué naturel. Ils unissent par ailleurs les formes droites aux formes arrondies. Une série convenant donc par excellence pour usage aussi bien privé que professionnel. Une note esthétique dans chaque hall d'entrée ou pièce. Maxime Szyf et Gerard Kerklaan ont créé des crochets avec ou sans cintre, un portemanteau mural, une table d'appoint, un tube pour cintres avec fixation au plafond ou au mur et des cintres. Tous ces articles sont en vente séparément, mais peuvent également parfaitement se combiner.









TUBULUST

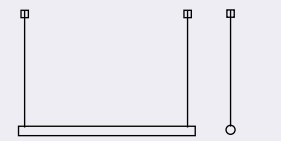

70 - 200 cm
26,6 - 78,7 inch

3,2 cm
1,3 inch

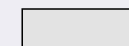

INOX



TUBULUSTW

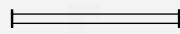

70 - 200 cm
27,6 - 78,7 inch



3,2 cm
1,3 inch

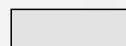

INOX



TUBULUSW



80 - 100 - 120 cm
31,5 - 39,4 - 47,2 inch



38 cm
15 inch

15 cm
5,9 inch

Corps

Tube



Grey

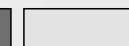

INOX



Black



White



TUBULUS H

○ □ | 3,2 cm
 — — | 1,3 inch
 3,2 cm 5,3 cm
 1,3 inch 2,1 inch

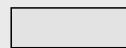

INOX



TUBULUS HI0K



 | 17 cm
 6,7 inch

45,5 cm 10 cm
 17,9 inch 3,9 inch

Hanger Hook



Beech INOX



TUBULUS HK MAGNÉFIQUE



45,5 cm
17,9 inch

Hanger

6,3 cm
2,5 inch

Hook

21 cm
8,3 inch

Magnet

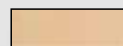

Beech

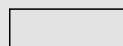

INOX



Black



TUBULUS 80



45,5 cm
17,9 inch

Hanger

17 cm
6,7 inch

2,5 cm
1 inch

Hook



Beech



INOX



TUBULUS I00 RIJKSMUSEUM



19,5 cm
7,6 inch

43,5 cm
17,1 inch

2,3 cm
0,9 inch

Hanger

Hook



Dark grey plastic INOX



White plastic

See reference pages 291 and 319

TUBULUS CT5043



43 cm
16,9 inch

50 cm
19,7 inch

Column and base



INOX

Top

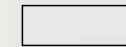

Glass



TUBULUS CT5057



50 cm
19,7 inch

Column and base

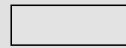

INOX

Top

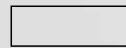

Glass



TUBULUS CT7043



70 cm
27,6 inch

Column and base

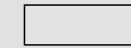

INOX

Top

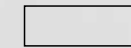

Glass



SPRING

design Pelikan & Co, Denmark



SPRING

Spring is een volledig, maar vooral flexibel garderobesysteem. Het door het Deense bureau Pelikan & Co. ontworpen systeem is gemakkelijk verplaatsbaar. Door de bijzondere s-vorm schuiven de verschillende onderdelen gemakkelijk in elkaar, waardoor het systeem weinig opbergruimte vraagt. De bijpassende kleerhangers, paraplubak, brochure- en tijdschriftenstandaards ogen al net zo speels.

Spring is a complete yet versatile cloakroom system. The system designed by the Danish bureau Pelikan & Co. is easy to move. Thanks to the unusual S-form the various units can slide easily together so that the system takes up little space. The accompanying coat hangers, umbrella stand, brochures and magazine stands match the stylish design.

Spring ist ein ausgereiftes, vor allem jedoch flexibles Garderobensystem. Das von der dänischen Agentur Pelikan & Co. entworfene System ist mühelos umsetzbar und ortsbeweglich. Dank der besonderen S-Form lassen sich die verschiedenen Teile leicht ineinander schieben. Folglich benötigt das System nur wenig Stauraum. Das Design der dazu passenden Kleiderbügel, Schirmständer, Broschüren- und Zeitschriftenhalter folgt der verspielten Linienführung.

Spring est un programme complet, mais surtout flexible, de systèmes de vestiaires. Cette gamme conçue par le bureau danois Pelikan & Co. peut facilement être déplacée. Grâce à leur forme particulière en S, les divers éléments s'emboîtent facilement et demandent donc peu de volume de rangement. Les cintres, le porte-parapluies et les présentoirs pour brochures et journaux, qui accompagnent ce produit ont une apparence tout aussi riche de fantaisie.

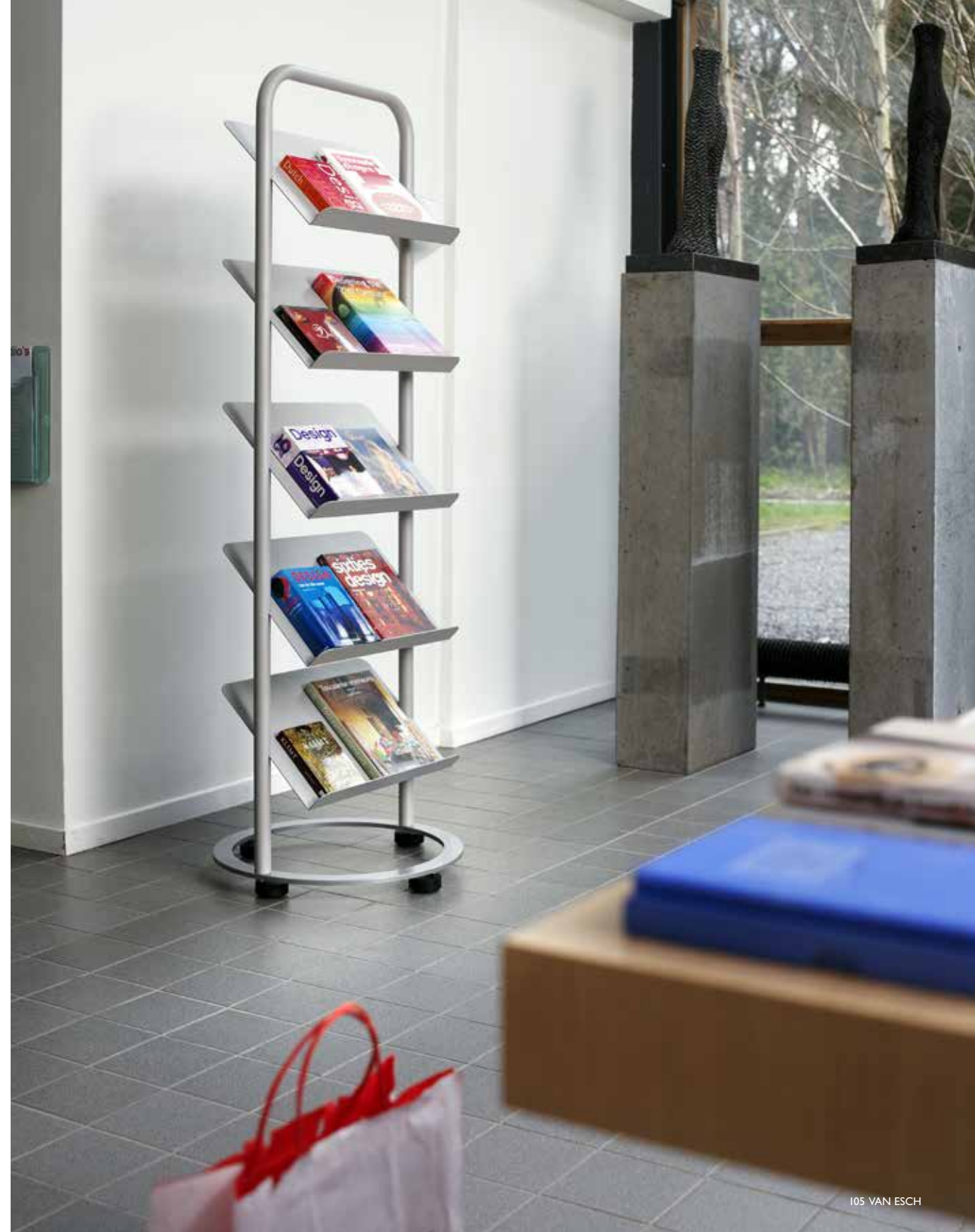





108 VAN ESCH



SPRING G+

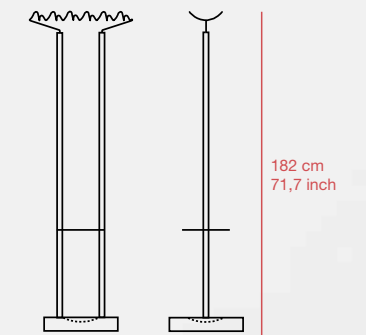

59 cm
23,2 inch

42 cm
16,5 inch

182 cm
71,7 inch

Tubes

Base, hooks and umbrella ring

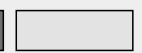
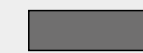

vE 7377

RAL 9006



vE 9311

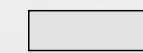

vE 9306

109 VAN ESCH

SPRING DV

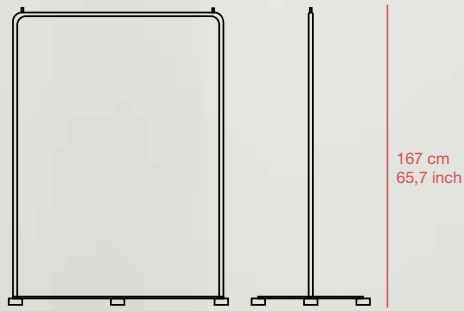

120 cm
47,2 inch

60 cm
23,6 inch

167 cm
65,7 inch

Tubes

Base

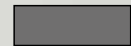

VE 7377

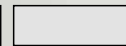

RAL 9006

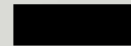

VE 9311



VE 9306



SPRING 70

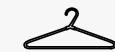

20 cm
7,9 inch

45 cm
17,7 inch

Hook

Hanger



Black plastic



RAL 9006

SPRING P

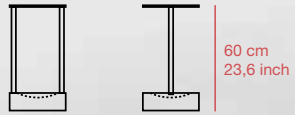

32 cm
12,6 inch

32 cm
12,6 inch

60 cm
23,6 inch

Tubes

Top and base



VE 7377

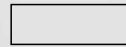

RAL 9006



VE 9311

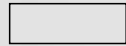

VE 9306



SPRING BI

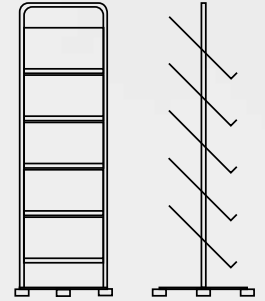

50 cm
19,7 inch

50 cm
19,7 inch

167 cm
65,7 inch

Base

Tubes and brochure holders



RAL 9006



VE 7377



VE 9311



VE 9306



vanEsch

CHASE

design Michiel van der Kley, The Netherlands



CHASE

In de serie Chase is een hoofdrol weggelegd voor het ontwerp. Verdwijnt een kapstok meestal uit het oog als er jassen aan hangen, in de ontwerpen van Michiel van der Kley is dat niet het geval omdat de haakjes bevestigd zijn aan de binnenkant. Chase is er in verschillende uitvoeringen. Het staande model heeft door de taps toelopen de 'benen' iets van een buitenaards wezen. De vormgeving van wandkapstok Chase W is speels, maar meer ingetogen. Beide zijn gemaakt van geëpoxeerd staalplaat en in meerdere kleuren en uitvoeringen verkrijgbaar.

In the Chase series the design is central. Coat stands usually disappear from view when coats are on them. In Michiel van der Kley's designs this is not the case as the hooks are mounted on the inside. Chase is available in various versions. The standing model has an extraterrestrial feel due to its tapering 'legs'. The design of the Chase W wall coat rack is playful, but more modest. Both have been made of epoxy coated steel and are available in various colours and models.

Bei der Produktreihe Chase spielt das Design die Hauptrolle. Während die meisten Garderoben unter den daran aufgehängten Mänteln verschwinden, verhält sich dies bei den Entwürfen von Michiel van der Kley anders. Dort sind die Haken an der Innenseite befestigt. Chase gibt es in verschiedenen Ausführungen. Die Stand-Ausführung hat auf Grund der konisch zulaufenden 'Standbeine' etwas von einem außerirdischen Wesen. Die Gestaltung der Wandgarderobe Chase W wirkt spielerisch, aber ein wenig zurückhaltender. Beide bestehen aus epoxiertem Stahlblech und sind in verschiedenen Farben und Ausführungen erhältlich.

Dans la série Chase, c'est au meuble qu'on attribue le rôle principal. Un portemanteau, la plupart du temps, disparaît sous les manteaux, mais en plaçant les crochets à l'intérieur du meuble, Michiel van der Kley a réussi à inverser cette tendance. Chase se décline en plusieurs modèles. Le modèle se tenant debout sur des « pattes » se terminant par des cônes, suggère une présence extraterrestre. Quant à l'esthétique du portemanteau mural Chase W, elle est fantaisiste mais réservée. Les deux modèles sont fabriqués en acier couvert de résine époxyde et sont disponibles en plusieurs couleurs et en plusieurs modèles.

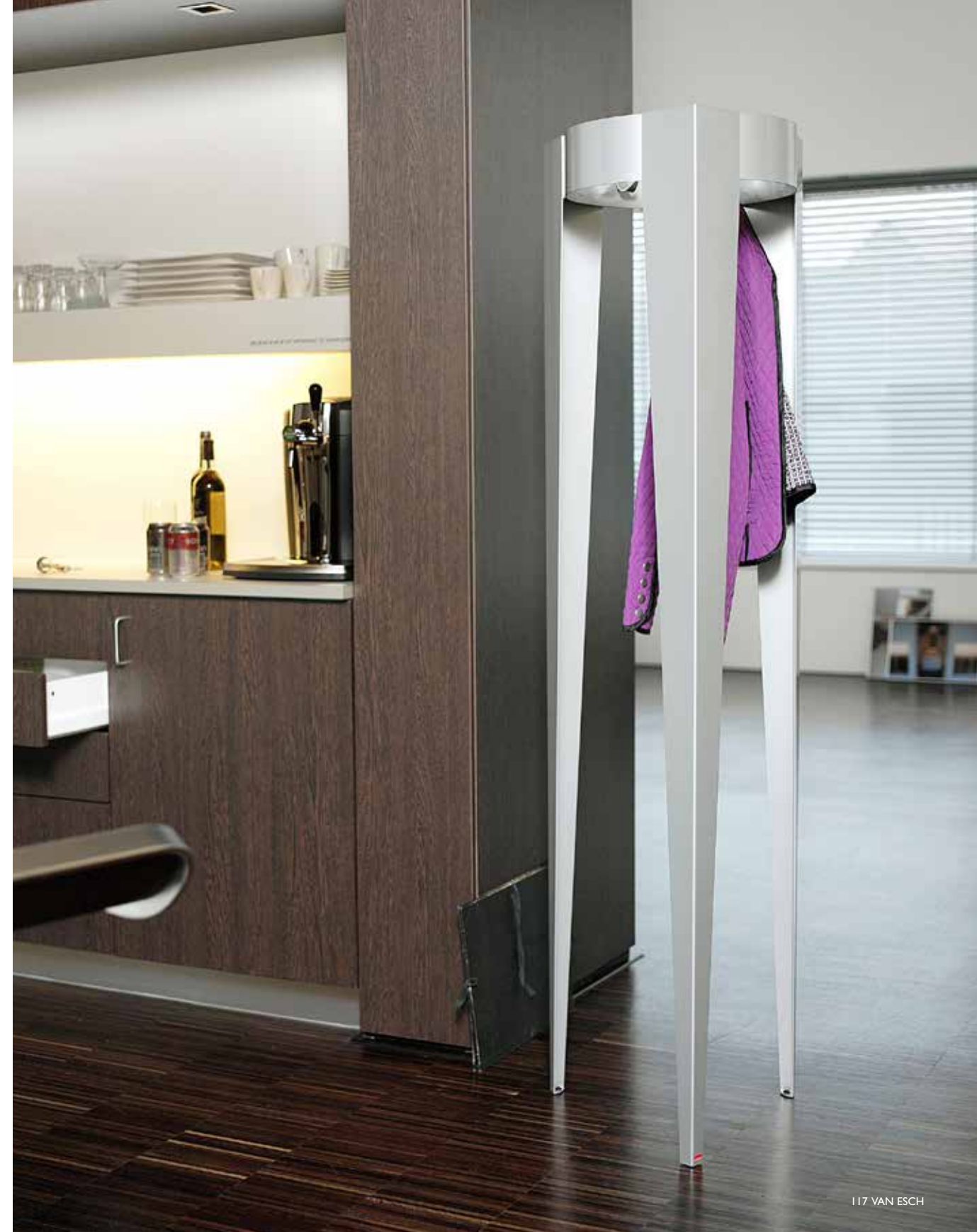

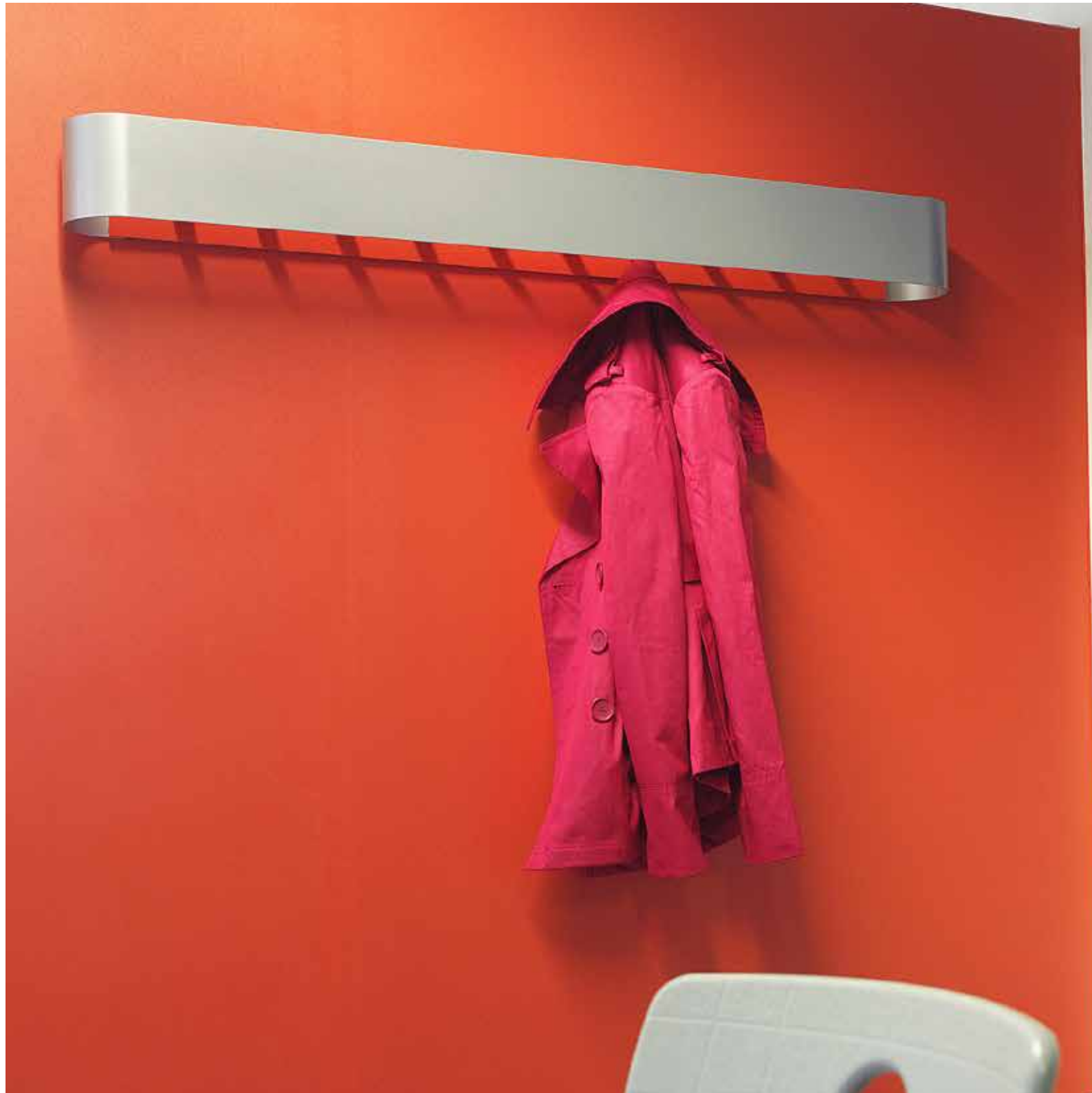

CHASE G

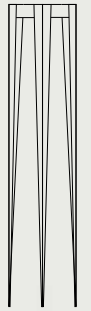

175 cm
68,9 inch

47 cm
18,5 inch



RAL 9011

RAL 9006



RAL 9010

RAL 3002



RAL 2004

RAL 6018



CHASE W



12 cm
4,7 inch

80 - 100 - 120 cm 12 cm
31,5 - 39,4 - 47,2 inch 4,7 inch

Front

Wall strip

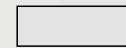

RAL 9006



RAL 9011

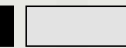

RAL 9006

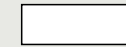

RAL 9010



RAL 3002



RAL 2004



RAL 6018



vanEsch
CORNER GUY
design Ineke Hans, The Netherlands



CORNER GUY

Eenvoud. Dat was voor designer Ineke Hans het uitgangspunt bij het ontwerp van Corner Guy. De functie van de garderobestandaard met parapluhouder spreekt voor zich, maar door de krachtige lijnen springt het ontwerp toch in het oog. De vorm van de kapstok maakt hem uitermate geschikt om in een hoek te plaatsen. Daarnaast kunnen er ook goed groepen mee gevormd worden.

Simplicity. That was the basis principle for designer Ineke Hans in her design of Corner Guy. The function of the coat stand with umbrella stand speaks for itself; however, the design catches the eye due to its strong contours. The shape of the coat stand lends itself exceedingly well for a corner position. In addition, several Corner Guy coat stands can form a group.

Einfachheit. Das war für Designerin Ineke Hans der Ausgangspunkt beim Entwurf des Corner Guy. Die Funktion des Garderobenständers mit Schirmablage spricht für sich, dank der kraftvollen Linienführung fällt auch das Design ins Auge. Dank ihrer Form eignet sich die Garderobe besonders gut für die Aufstellung in einer Ecke. Ferner können damit auch gut Gruppen gebildet werden.

Simplicité. Tel est le point de départ adopté par la designer Ineke Hans pour créer Corner Guy. La fonction de ce portemanteau avec porte-parapluies est évidente, mais cette création se distingue par ses lignes puissantes. La forme du portemanteau le prédispose à prendre place dans un coin. Mais il est également parfaitement approprié à être mis en groupes.





CORNER GUY

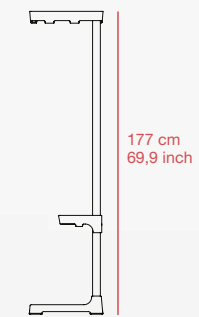

42,5 cm
16,7 inch

- Black
- Off-white
- Dark grey

vanEsch

DODICI DRIP QUATTRO SEI

design James Irvine (*1958 - †2013), Italy



DODICI DRIP QUATTRO SEI

De vier ontwerpen van de Britse designer James Irvine in de collectie van van Esch staan door hun karakteristieke verschijning ogenschijnlijk op zichzelf. En toch sluiten ze perfect op elkaar aan. Dat hangt vooral samen met hun krachtige uitstraling. Zo lijken de twaalf haken van garderobestandaard Dodici als karton gevouwen. Quattro, een wandkapstok met twee dubbele haken, doet dan weer uiterst eenvoudig aan. Evenals Sei, een wandkapstok met drie dubbele haken. Bij paraplubak Drip springen vooral de afgeronde hoeken in het oog. Daarnaast heeft de uitneembare opvangbak dezelfde kleur als het frame dat aan de binnenzijde is voorzien van twee haken voor kleine paraplu's.

Due to their characteristic appearance the four designs of British designer James Irvine in the van Esch collection look totally different. And yet they go together perfectly. Particularly because of their robust look. The twelve hooks of the coat stand Dodici, for example, seem to have been folded like carton. Quattro, a wall coat rack with its double hooks, appears extremely simple. As does Sei, a wall coat rack with three double hooks. In the design of umbrella stand Drip it is the curved edges in particular that catch your eye. Likewise with the removable drip tray in the same colour as the frame, which on the inside has two hooks for small umbrellas.

Die vier Entwürfe des britischen Designer James Irvine in der Kollektion von van Esch haben alle ihre eigenständige, charakteristische Ausstrahlung. Und doch passen sie perfekt zueinander. Das hängt hauptsächlich mit ihrem starken Erscheinungsbild zusammen. Die zwölf Haken des Garderobenständers Dodici muten wie aus Karton gefaltet an. Quattro, eine Wandgarderobe mit zwei Doppelhaken, besticht wiederum durch ihre äußerst schlichte Linienführung. Ebenso wie Sei, eine Wandgarderobe mit drei Doppelhaken. Beim Schirmständer Drip fallen insbesondere die abgerundeten Ecken auf. Ferner hat die herausnehmbare Abtropfschale dieselbe Farbe wie der Rahmen, der auf der Innenseite mit zwei Haken für kleine Schirme versehen ist.

Les quatre créations du designer britannique James Irvine qui font partie de la collection de van Esch ont chacune une apparence caractéristique qui les distingue. Pourtant, elles sont parfaitement en harmonie. Cela est surtout dû à la puissance de leur apparence. Ainsi, les douze patères du vestiaire Dodici semblent être en carton plié. Quattro, un portemanteau mobile avec deux doubles patères, semble la simplicité même. Comme Sei, un portemanteau mobile pourvu de trois doubles patères. Le bac à parapluies Drip est surtout remarquable en raison de ses coins arrondis. L'égouttoir amovible est en outre de la même couleur que le châssis, qui est pourvu à l'intérieur de deux crochets pour les petits parapluies.





DODICI

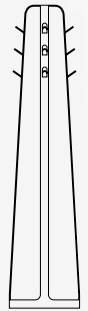

180 cm
70,9 inch

42 cm
16,5 inch



RAL 9011

RAL 9006



RAL 9010



RAL 3002



RAL 2004



See reference page 307

DRIP



31,5 cm
12,4 inch

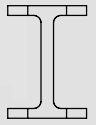

45 cm
17,7 inch

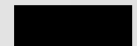

RAL 9011

RAL 9006



RAL 9010



See reference page 307



QUATTRO

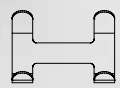

25 cm
9,8 inch



7,5 cm
3,0 inch

18 cm
7,1 inch



RAL 9011

RAL 9006



RAL 9010



SEI

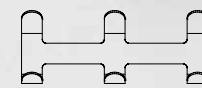

45 cm
17,7 inch



7,5 cm
3,0 inch

18 cm
7,1 inch



RAL 9011

RAL 9006



RAL 9010



WINGS

Met of zonder jassen, wandkapstok Wings van het Deense ontwerpbureau D-Vision is een bijzonder ontwerp. Doordat de geïntegreerde kleeerhangers draaibaar zijn, neemt de kapstok weinig ruimte in. De uitvoering in degelijk aluminium benadrukt daarnaast het luchtige uiterlijk. Wings is verkrijgbaar in zes verschillende maatvoeringen.

With or without coats, wall coat rack Wings by the Danish design bureau D-Vision is an extraordinary design. With the integrated rotatable coat hangers the coat rack occupies the minimum of space. The solid aluminium structure emphasises the no-nonsense look. Wings is available in six different sizes.

Egal, ob mit oder ohne Jacken, die Wandgarderobe Wings der dänischen Agentur D-Vision ist ein ganz besonderes Design. Weil die integrierten Kleiderbügel drehbar sind, nimmt die Garderobe wenig Raum ein. Die Ausführung in Aluminium betont die leichte Linienführung. Wings ist in sechs verschiedenen Maßen erhältlich.

Avec ou sans manteaux, le portemanteau Wings du bureau danois D-Vision est une création particulière. Du fait que les cintres intégrés sont tournants, le portemanteau prend peu de place. La réalisation en aluminium solide souligne la légèreté de l'ensemble. Wings est disponible dans six dimensions différentes.







WINGS



52 cm
20,5 inch

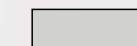

Aluminium



22,5 cm
8,9 inch

30 - 180 cm
11,8 - 70,9 inch

vanEsch

PRIMA VISTA

design Toon van Tuijl (*1959 - †2006), The Netherlands



PRIMA VISTA

Met de door Toon van Tuijl ontworpen brochurehouder Prima Vista zijn brochures, boeken en tijdschriften altijd goed zichtbaar. De houder, die vrij in de ruimte wordt geplaatst, is een heuse blikvanger. Aan het metalen frame hangen vijf legborden. Een speciale magnetische steun maakt de brochurehouder geschikt voor kleinere papierformaten.

Prima Vista, the brochure stand designed by Toon van Tuijl, displays brochures, books and magazines clearly. The stand, which is freestanding, is a real eye-catcher. Five brochure holders are attached to the metal frame. A special magnetic support makes the stand suitable for smaller paper sizes.

Die von Toon van Tuijl gestaltete Broschürenhalter Prima Vista bringt Broschüren, Bücher und Zeitschriften optisch immer voll zur Geltung. Diese frei im Raum stehende Auslage ist ein wahrer Blickfang. In den Metallrahmen sind fünf Broschürenhalterungen eingehängt. Eine magnetische Spezialstütze erlaubt auch die Präsentation kleinerer Papierformate auf dieser Broschürenhalter.

Avec le présentoir pour brochures Prima Vista, créé par Toon van Tuijl, les brochures, livres et magazines sont toujours bien en vue. Le présentoir, qui peut être placé librement dans une pièce, accroche immanquablement l'attention. Cinq porte-brochures sont suspendus au support métallique. Un support magnétique spécial permet d'adapter le présentoir à des formats de papier plus petits.



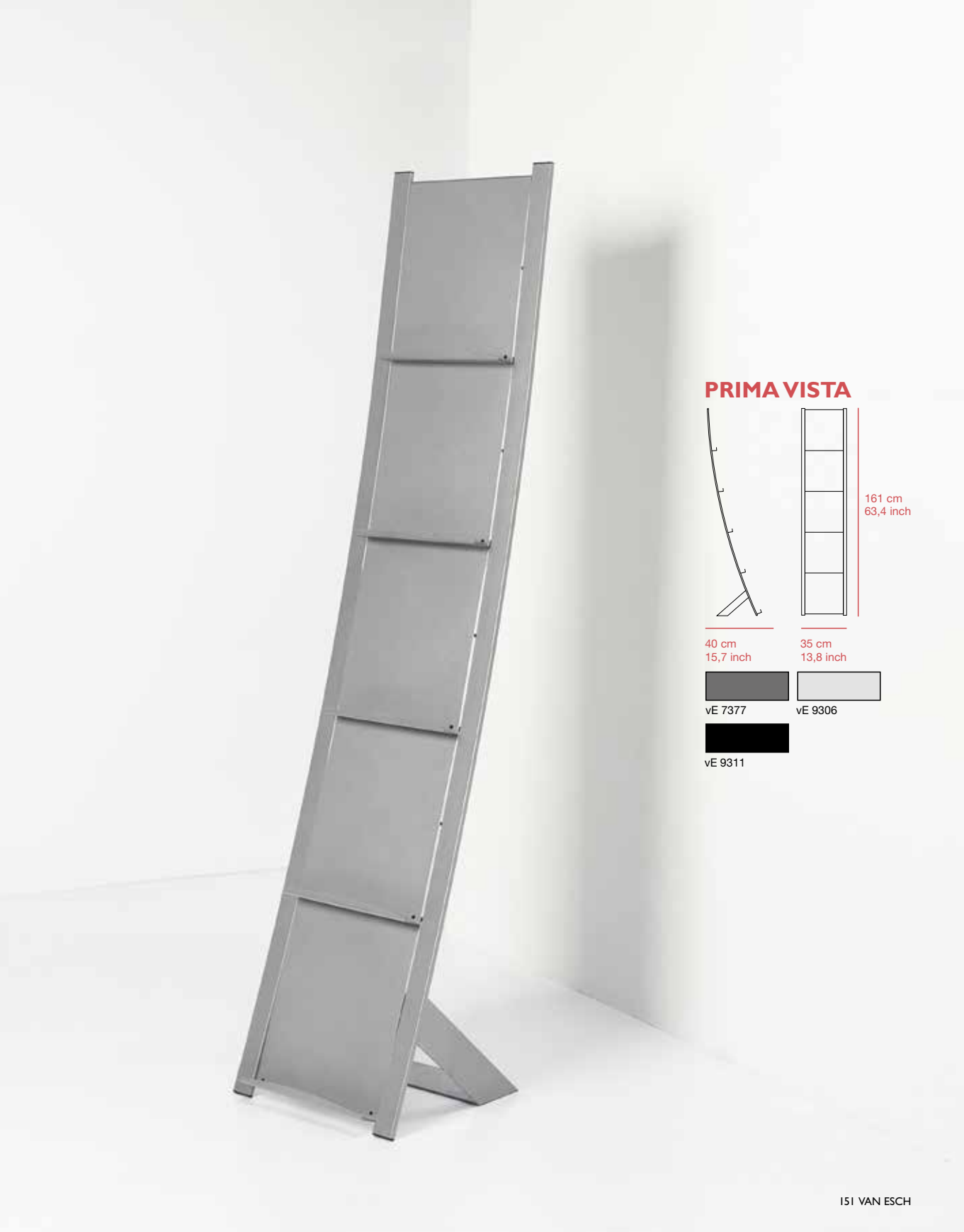

PRIMA VISTA

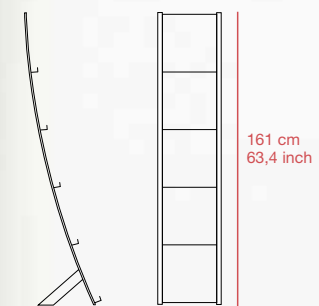

40 cm
15,7 inch

35 cm
13,8 inch

161 cm
63,4 inch



vE 7377

vE 9306



vE 9311

vanEsch
SIX PACK
design Pelikan & Co, Denmark

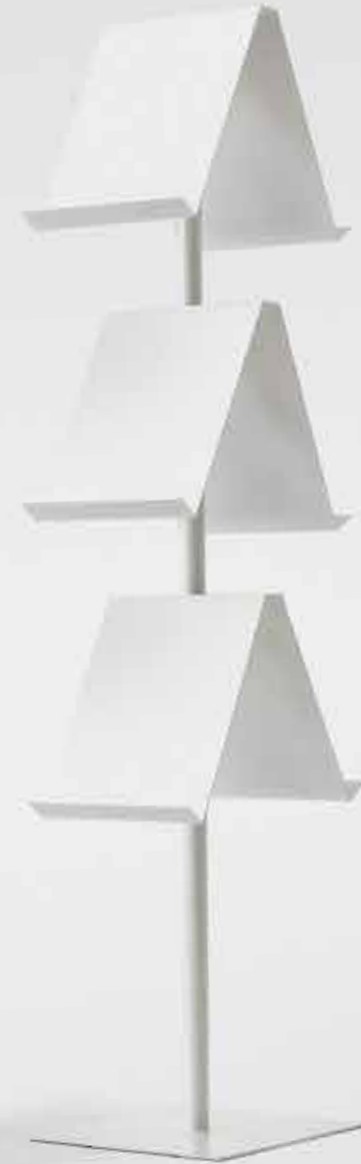
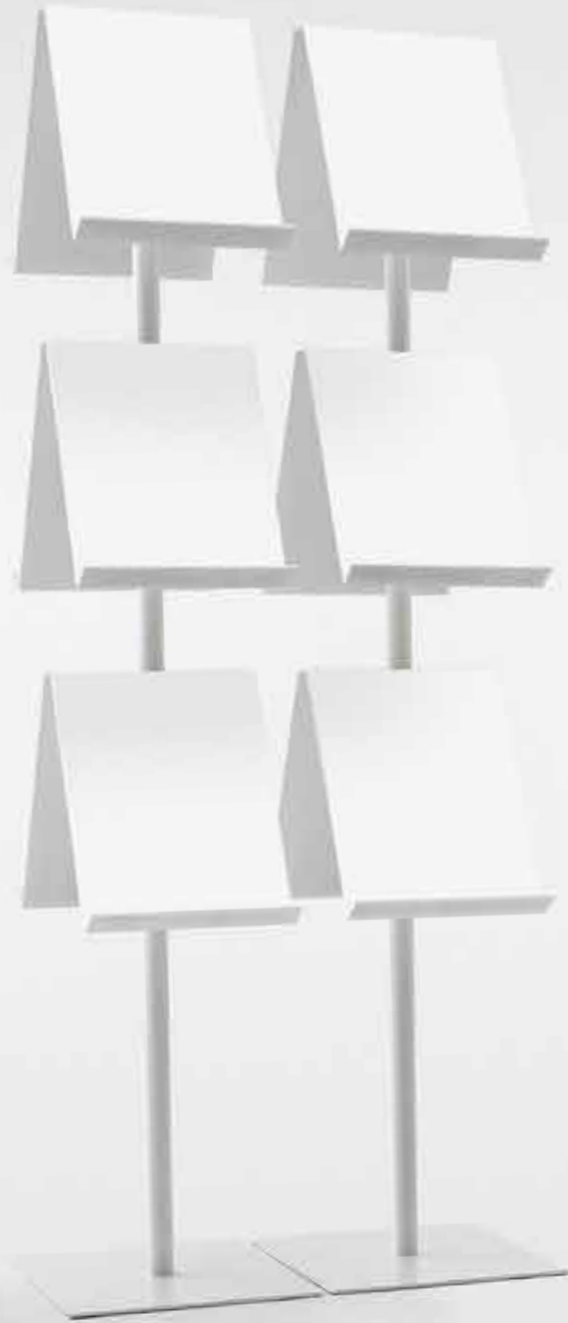

SIX PACK

De naam zegt het al: Six Pack is voorzien van zes brochurehouders. Doordat deze diagonaal tegen de 'stam' zijn geplaatst doet de door Pelikan & Co. ontworpen standaard enigszins denken aan een boom. Door het ranke karakter van dit speelse ontwerp is Six Pack gemakkelijk in serie te plaatsen.

The name says it all: The brochure stand Six Pack has six presentation surfaces. These are placed diagonally against the "trunk" giving the stand, designed by Pelikan & Co., a tree-like appearance. Thanks to its slender design, the playful Six Pack can easily be placed in series.

Der Name sagt es bereits: Six Pack verfügt über sechs Präsentationsebenen. Mit der Diagonalanordnung dieser Ebenen am „Stamm“ erinnert dieses von Pelikan & Co. entworfene Bröchurehalter an einen Baum. Dank der ranken Ausführung dieses spielerischen Entwurfs lassen sich mehrere Six Packs auch in einer Reihe sozusagen als Wald aufstellen.

Le nom l'annonce déjà : Six Pack est pourvu de six surfaces de présentation. Celles-ci étant placées en diagonale par rapport au « tronc », ce présentoir conçu par Pelikan & Co. fait un peu penser à un arbre. La sveltesse de cette création riche de fantaisie fait que Six Pack peut facilement être placé en série.





SIX PACK

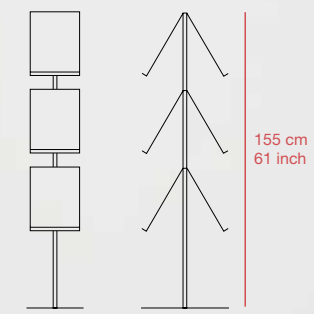

155 cm
61 inch

30 cm
11,8 inch

46 cm
18,1 inch

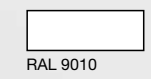

RAL 9010

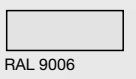

RAL 9006

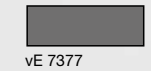

VE 7377

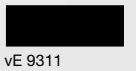

VE 9311

vanEsch

FOLDR

design Coen van Ham, The Netherlands



FOLDR

Foldr is een brochurehouder voor aan de wand. Voor het ontwerp heeft designer Coen van Ham zich laten inspireren door een vel papier. De naar buiten gevouwen delen fungeren als dragers voor magazines en folders. Door het efficiënte materiaalgebruik neemt deze fragiel ogende brochurehouder nauwelijks plaats in.

Foldr is a brochure stand for on the wall. The design created by designer Coen van Ham has been inspired by a sheet of paper. The parts that have been folded outwards function as holders for magazines and brochures. Thanks to the efficient use of materials this fragile-looking brochure stand hardly takes up any space.

Foldr ist ein Broschürendisplay für die Wandmontage. Designer Coen van Ham hat sich für den Entwurf von einem Blatt Papier inspirieren lassen. Die nach außen gefalteten Teile dienen als Träger für Zeitschriften und Broschüren. Die grazil wirkende Auslage nimmt dank effizientem Materialeinsatz kaum Raum ein.

Foldr est un présentoir mural. Le créateur Coen van Ham s'est laissé inspirer par une feuille de papier. Les éléments repliés vers l'extérieur constituent les supports pour les magazines et les dépliants. L'utilisation efficace du matériau fait que ce présentoir de brochures à l'aspect fragile n'occupe presque pas d'espace.



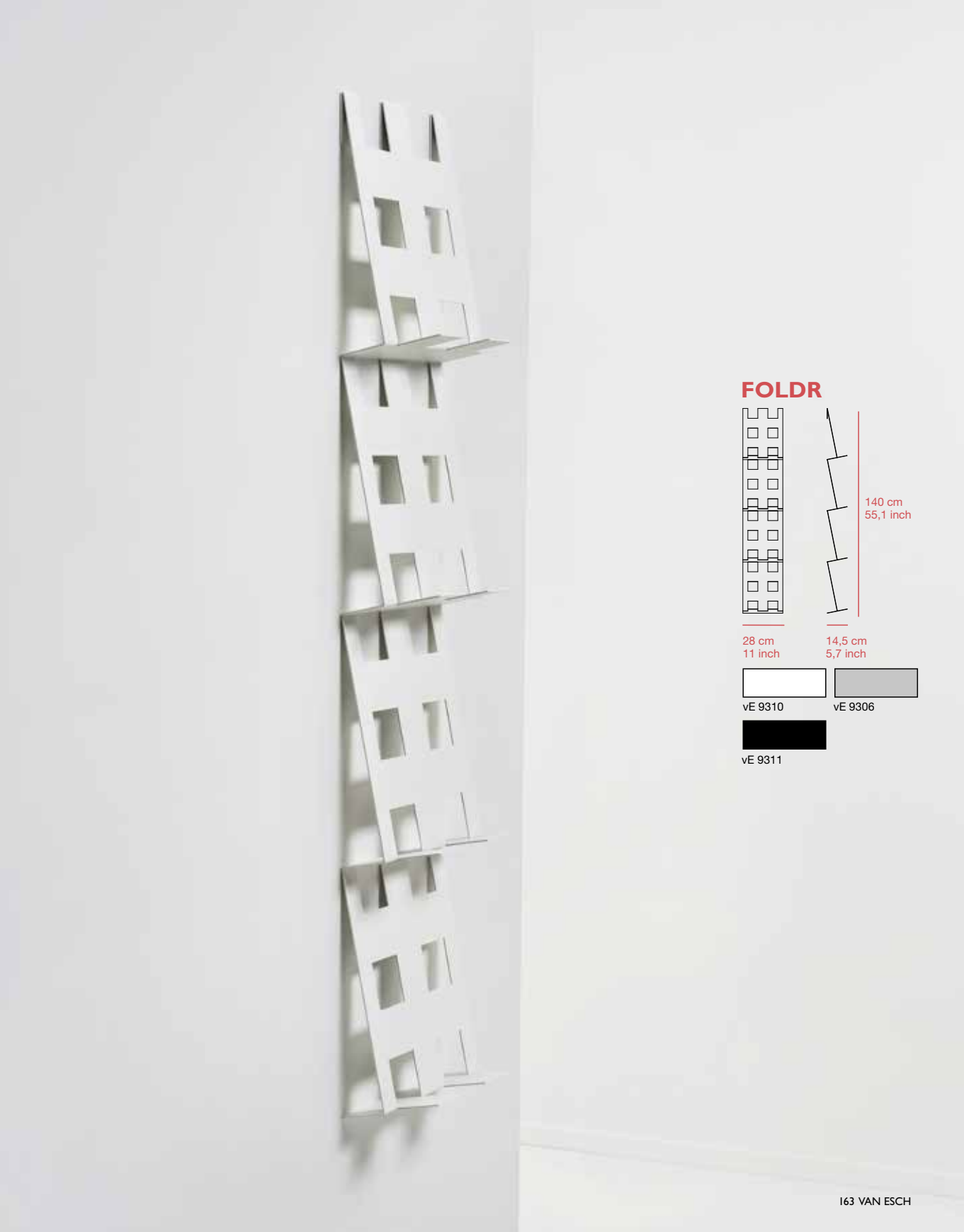

FOLDR

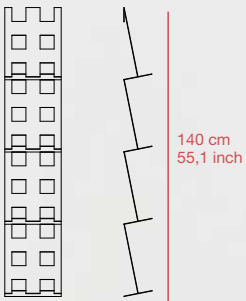

28 cm
11 inch

14,5 cm
5,7 inch



vE 9310



vE 9306

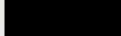

vE 9311



LISTON

Het is niet de spiegel zelf, maar de lijst die de spiegel maakt. Zoveel maakt de door het Deense bureau Pelikan & Co. ontworpen spiegel Liston wel duidelijk. Door de nauwelijks zichtbare lijst lijkt de spiegel op te gaan in de ruimte. Die indruk wordt nog eens versterkt door dat spiegel en aluminium lijst één vlak vormen. Liston is er in verschillende maten, variërend van 50 bij 50 tot 100 bij 200 centimeter.

It is not the mirror itself, but the frame that makes the mirror. That much is clear from the Liston mirror designed by Danish bureau Pelikan & Co. With the scarcely noticeable frame the mirror blends in effortlessly with its surroundings. This feel is emphasized by the mirror and frame forming a single surface. Liston is available in various sizes, ranging from 50 x 50 to 100 x 200 centimetres.

Die Ausstrahlung eines Spiegels wird nicht vom Spiegel selbst, sondern hauptsächlich von seinem Rahmen bestimmt. Das wird einem beim von der dänischen Agentur Pelikan & Co. entworfenen Spiegel Liston bestimmt klar. Mit der kaum sichtbaren Leiste geht der Spiegel gleichsam im Raum auf. Dieser Eindruck wird noch dadurch verstärkt, dass Spiegel und Aluminium eine einzige Fläche bilden. Liston gibt es in verschiedenen Größen von 50 auf 50 bis zu 100 auf 200 Zentimetern.

Ce n'est pas le miroir qui fait le miroir, mais son cadre. C'est ce que prouve clairement le miroir Liston, création du bureau danois Pelikan & Co. Son cadre à peine visible fait fondre le miroir dans l'espace. Cette impression est encore renforcée du fait que le miroir et son cadre en aluminium forment une seule surface. Liston est disponible dans diverses tailles, de 50x50 à 100x200 centimètres.

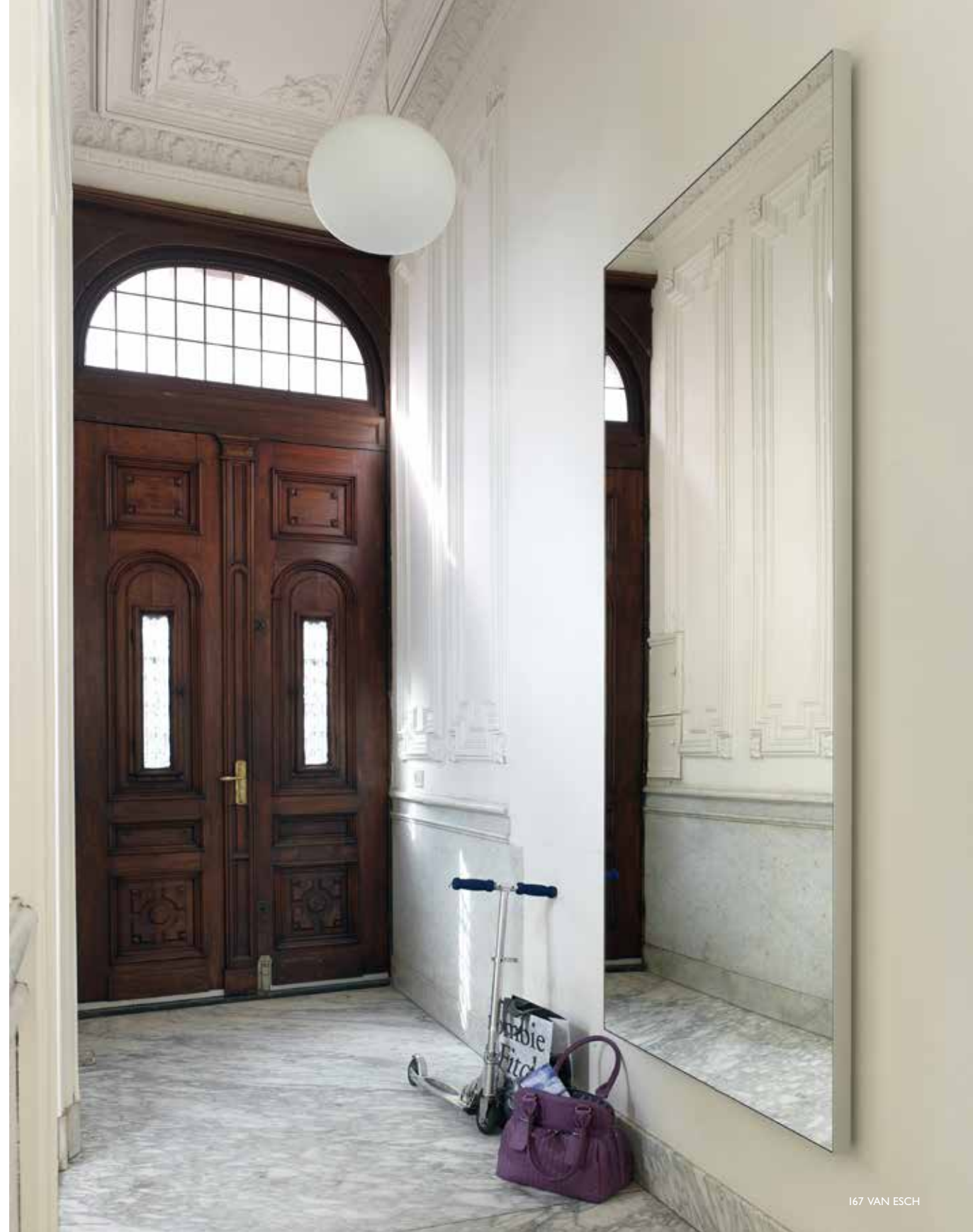



LISTON

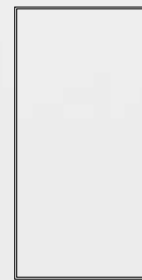

50 - 100 cm
19,7 - 39,4 inch



Aluminium

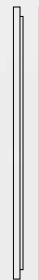

50 - 200 cm
19,7 - 78,7 inch

6 cm
2,4 inch



SILO

Silo is de naam van een verzameling cilindervormige paraplu- en prullenbakken met een opvallend ingetogen uiterlijk. De bakken zijn uitgevoerd in roestvast staal of in de kleuren zwart en metallic grijs. Het strakke design is van de hand van ontwerpteam van Esch.

Silo is the name of a collection of cylindrical umbrella stands and waste-paper bins with a strikingly modest appearance. They are made of stainless steel or steel finished in black and metallic grey. The sleek design is the work of the van Esch team.

Silo heißt eine Kollektion zylindrischer Schirmständer und Papierkörbe mit auffallend geradlinigem Design. Die Modelle sind entweder in Edelstahl oder in den Farben Schwarz und Grau Metallic erhältlich. Das elegante Design stammt aus der Ideenwerkstatt des Designerteams van Esch.

Silo est le nom d'un ensemble de bacs à papiers et à parapluies, de forme cylindrique, à l'aspect remarquablement dépouillé. Ces bacs sont en acier inoxydable ou dans les couleurs noire ou gris métallique. Le design sobre a été conçu par l'équipe de création de van Esch.



SILO P2550

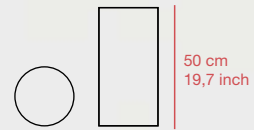

25 cm
9,8 inch



INOX

VE 9306

VE 9311



SILO PB2538

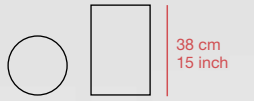

25 cm
9,8 inch



INOX

VE 9306

VE 9311





PICTOR

Een mooie verzameling, bijzondere voorwerpen of fraai glaswerk verdienen een prominente plaats in woning of kantoor. Bijvoorbeeld in een vitrinekast met ingebouwde spots. Daarin komen waardevolle spullen niet alleen prima tot hun recht, maar zijn ze ook nog eens veilig opgeborgen.

Door hun eenvoudige vormgeving leiden de vitrinekasten in het programma Pictor de aandacht nooit af van de inhoud. Pictor is verkrijgbaar in verschillende uitvoeringen en twee verschillende hoogtes. De vier bijgeleverde legborden zijn traploos verstelbaar.

An attractive collection, special items or beautiful glasswork all deserve a prominent place in a house or office. For example, in a display case with built-in spotlights. Not only do valuable items look their best in such display cases, but they can also be stored away safely. Thanks to their simple design the display cases in the Pictor series never distract attention from their contents. Pictor is available in different models and two different heights. The four shelves supplied can be adjusted to any chosen height.

Eine schöne Sammlung, kostbare Gegenstände oder elegante Gläser verdienen einen prominenten Platz in der Wohnung oder im Büro, zum Beispiel in einem Vitrinenschrank mit eingebauten Spots. Darin kommen wertvolle Sachen nicht nur voll zur Geltung, sondern werden auch noch sicher aufbewahrt. Die schlichte Gestaltung der Vitrinenschränke der Serie Pictor lenkt die Aufmerksamkeit nie vom Inhalt ab. Pictor ist in verschiedenen Ausführungen und zwei verschiedenen Höhen erhältlich. Die vier mitgelieferten Ablageplatten sind stufenlos verstellbar.

Une jolie collection, des objets particuliers ou de belles verreries demandent une place éminente dans votre logement ou votre bureau. Une armoire vitrine, par exemple, pourvue de spots encastrés. Non seulement elle mettra vos objets précieux en valeur, mais ils y seront en lieu sûr. Par leur design épuré, les armoires vitrines de la gamme Pictor ne détournent jamais l'attention de ce qu'elles contiennent. Pictor est disponible dans des modèles différents et deux hauteurs différentes. Les quatre tablettes fournies peuvent être installées à n'importe quelle hauteur.





180 VAN ESCH



181 VAN ESCH

PICTOR VA040

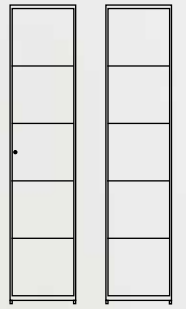

182 / 198 cm
71,7 / 78 inch

40 cm 40 cm
15,7 inch 15,7 inch



Aluminium RAL 9010

RAL 9011



PICTOR VA050

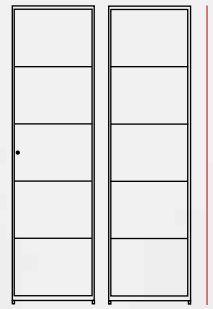

182 / 198 cm
71,7 / 78 inch

50 cm 50 cm
19,7 inch 19,7 inch



Aluminium RAL 9010

RAL 9011



PICTOR VA060



182 / 198 cm
71,7 / 78 inch

60 cm
23,6 inch

40 cm
15,7 inch



Aluminium



RAL 9010

RAL 9011



PICTOR VA080

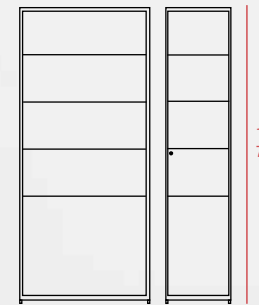

182 / 198 cm
71,7 / 78 inch

80 cm
31,5 inch

40 cm
15,7 inch

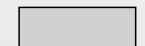

Aluminium

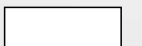

RAL 9010

RAL 9011



PICTOR VA100



182 / 198 cm
71,7 / 78 inch

100 cm
39,4 inch

40 cm
15,7 inch



Aluminium RAL 9010

RAL 9011



PICTOR VA040K

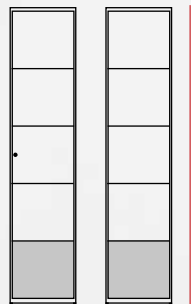

182 cm
71,7 inch

40 cm
15,7 inch

40 cm
15,7 inch



Aluminium RAL 9010

RAL 9011



PICTOR VA050K

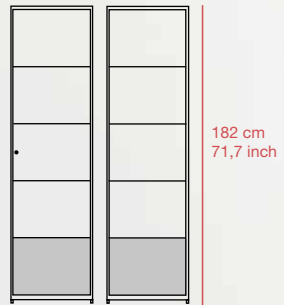

50 cm
19,7 inch

50 cm
19,7 inch



Aluminium RAL 9010

RAL 9011



PICTOR VA060K

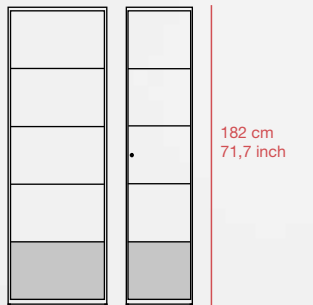

60 cm
23,6 inch

40 cm
15,7 inch



Aluminium RAL 9010

RAL 9011



PICTOR VA080K

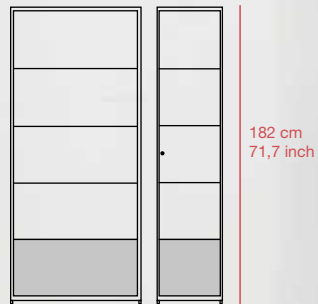

80 cm
31,5 inch

40 cm
15,7 inch



Aluminium



RAL 9010



RAL 9011



PICTOR VA100K



100 cm
39,4 inch

40 cm
15,7 inch



Aluminium



RAL 9010

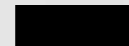

RAL 9011



vanEsch
AQUARIUS H
design van Esch Team, The Netherlands



AQUARIUS H

Grote kasten, kleine kastjes, postvakken naast elkaar of boven elkaar. De lockers uit het programma Aquarius zijn door de vele mogelijkheden vooral functioneel.

De strak vormgegeven romp is uitgevoerd in wit. De deuren zijn standaard verkrijgbaar in wit, zwart, licht- of middelgrijs. Deuren en zijpanelen zijn tegen een meerprijs leverbaar in circa 150 verschillende kleuren of houtdecors. De kasten zijn voorzien van een zwarte metalen plint met stelvoeten.

Large lockers, small cabinets, pigeon holes, alongside or one above the other. The lockers from the Aquarius series are thanks to the many possibilities they offer highly functional. The sleek body is finished in white. The doors are available as standard in white, black, light grey and medium grey. Doors and side panels are available for a supplement in approximately 150 different colours and wood effects. The models come with black metal plinths and adjustable feet.

Große Schränke, kleine Schränke, Postfächer neben- oder übereinander. Die Schränke aus dem Programm Aquarius sind verfügen über zahlreiche funktionelle Gestaltungsmöglichkeiten. Den geradlinig gestalteten Korpus gibt es in Weiß. Die Türen sind serienmäßig in Weiß, Schwarz und in Hell- oder Mittelgrau erhältlich. Türen und Seitenteile sind gegen Aufpreis in etwa 150 verschiedenen Farben oder Holzoptiken erhältlich. Die Schränke sind mit einer schwarzen Sockel aus Metall und Stellfüßen versehen.

Grandes armoires, petites armoires, boîtes aux lettres juxtaposées ou superposées. Les casiers de la gamme Aquarius sont surtout fonctionnels par leurs nombreuses possibilités d'utilisation.

Le corps au design sobre est réalisé en blanc. Les portes sont disponibles de façon standard en blanc, en noir ou en gris clair ou moyen. Contre un supplément de prix, les portes et les panneaux latéraux de finition sont disponibles dans environ 150 couleurs ou décors bois différents. Les armoires sont pourvues d'une plinthe métallique noire avec pieds réglables.





111



115



118



122



126



130



134



138



142



146



150

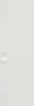

116



119



123



127



131



135



139



143



147



151



120



124



128



132



136



140



144



148



152



112



125



129



133



137



141



145



149



121









AQUARIUS HG

HG2302/P
HG2402/P

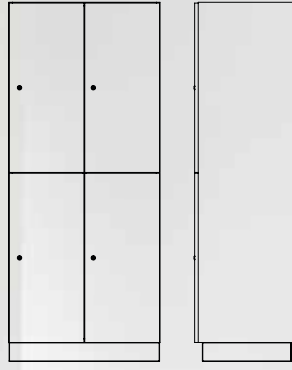

190 cm
74,8 inch

60 / 80 cm
23,6 / 31,5 inch

52 cm
20,5 inch



AQUARIUS HG

HG2301/P
HG2401/P

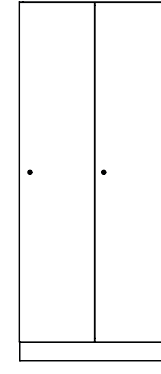

60 / 80 cm
23,6 / 31,5 inch

HG2302/P
HG2402/P

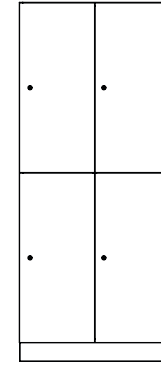

60 / 80 cm
23,6 / 31,5 inch

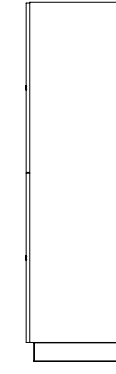

190 cm
74,8 inch

52 cm
20,5 inch

HG1301/P
HG1401/P

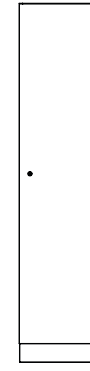

30 / 40 cm
11,8 / 15,7 inch

HG1302/P
HG1402/P



30 / 40 cm
11,8 / 15,7 inch

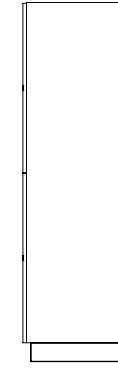

190 cm
74,8 inch

52 cm
20,5 inch

AQUARIUS HV

HV2304/P
HV2404/P

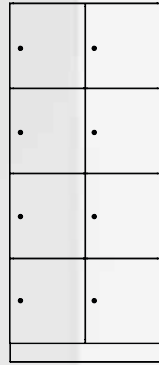

60 / 80 cm
23,6 / 31,5 inch

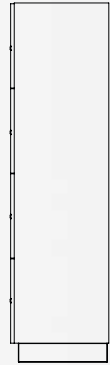

52 cm
20,5 inch

190 cm
74,8 inch



See reference pages 297 and 319

AQUARIUS HV

HV2303/P
HV2403/P

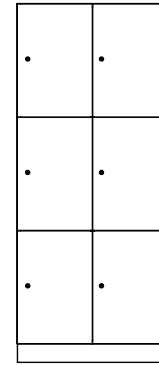

60 / 80 cm
23,6 / 31,5 inch

HV2304/P
HV2404/P

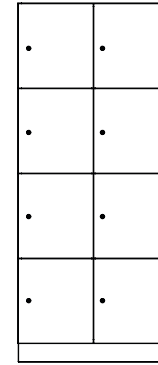

60 / 80 cm
23,6 / 31,5 inch

HV2305/P
HV2405/P

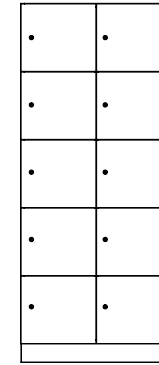

60 / 80 cm
23,6 / 31,5 inch

HV2306/P
HV2406/P

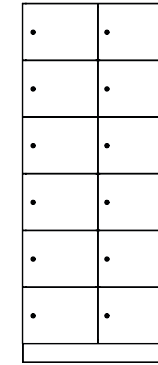

60 / 80 cm
23,6 / 31,5 inch

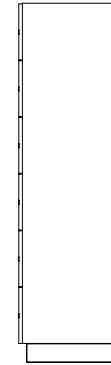

52 cm
20,5 inch

190 cm
74,8 inch

HV1303/P
HV1403/P

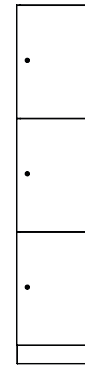

30 / 40 cm
11,8 / 15,7 inch

HV1304/P
HV1404/P



30 / 40 cm
11,8 / 15,7 inch

HV1305/P
HV1405/P

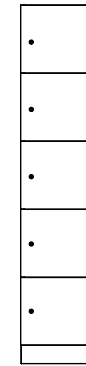

30 / 40 cm
11,8 / 15,7 inch

HV1306/P
HV1406/P

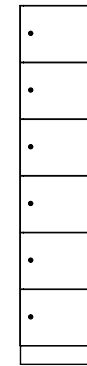

30 / 40 cm
11,8 / 15,7 inch

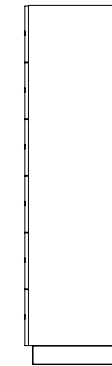

52 cm
20,5 inch

190 cm
74,8 inch

AQUARIUS HF

HF2403/P

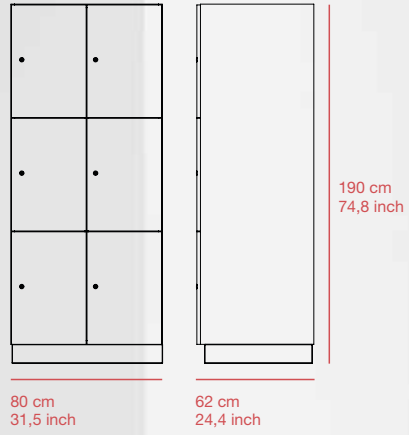

AQUARIUS HF

HF2403/P

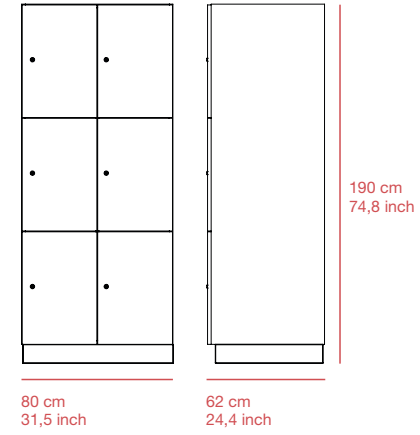

HF1403/P

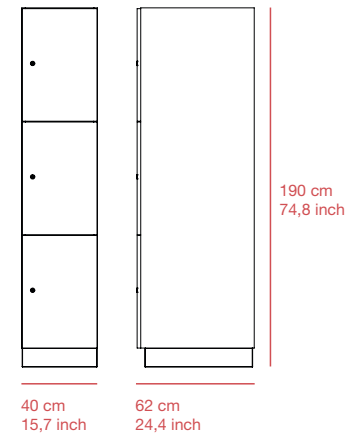

AQUARIUS HVL

HVL2302/P
HVL2402/P



60 / 80 cm
23,6 / 31,5 inch



52 cm
20,5 inch

132 cm
52,0 inch



See reference page 301

AQUARIUS HVL

HVL2302/P
HVL2402/P

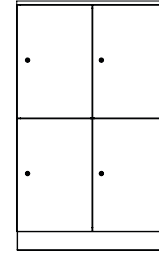

60 / 80 cm
23,6 / 31,5 inch

HVL2303/P
HVL2403/P

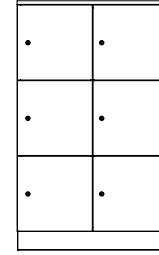

60 / 80 cm
23,6 / 31,5 inch

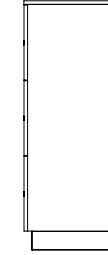

52 cm
20,5 inch

132 cm
52,0 inch

HVL1302/P
HVL1402/P



30 / 40 cm
11,8 / 15,7 inch

HVL1303/P
HVL1403/P

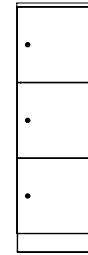

30 / 40 cm
11,8 / 15,7 inch

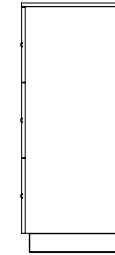

52 cm
20,5 inch

132 cm
52,0 inch

AQUARIUS HP

HP1306

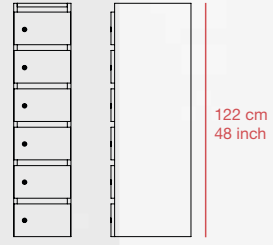

30 cm
11,8 inch

42 cm
16,5 inch



AQUARIUS HP

HP1304

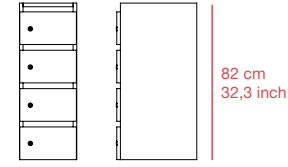

30 cm
11,8 inch

42 cm
16,5 inch

HP1305

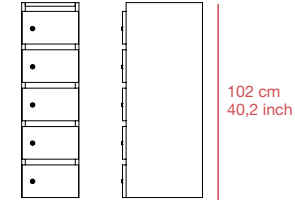

30 cm
11,8 inch

42 cm
16,5 inch

HP1306

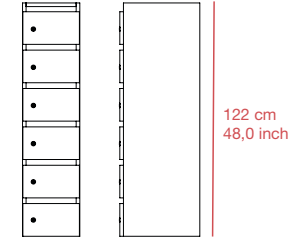

30 cm
11,8 inch

42 cm
16,5 inch

AQUARIUS H ACCESSORIES



H/CS cylinder lock



H/MS coin lock



H/PCS LS100 pin code lock



H/PCS Mauer pin code lock



NP number tag



NH1 name plate holder



NH2 name plate holder



NH3 name plate holder



NH4 number tag



NH4 number tag



NH5 card holder



SN key number tag



H/PN number tag

STANDAARD KLEUREN COLORIS STANDARD

Kleurcode S

romp wit, deuren en kantband wit (97/85), lichtgrijs (97/74), middelgrijs (97/75) of zwart (02/007)

Kleuren: www.van-esch.com

Colourcode S

body white, doors and edging in white (97/85), silvergrey 97/74, medium grey (97/75) or black (02/007)

Colours: www.van-esch.com

Farbkode S

Korpus weiß, Türe und gleichfarbiger Kanten weiß (97/85), silbergrau 97/74, mittelgrau (97/75) oder schwarz (02/007)

Farben: www.van-esch.com

Code coloris S

corps blanc, portes et bande de chant dans la même finition, blanc (97/85), gris argenté 97/74, mi-gris (97/75) ou noir (02/007)

Couleurs: www.van-esch.com

STANDARD COLOURS STANDARDFARBEN

Body



97/85

Doors + Panels



97/85



97/74



97/75



02/007

UNIKLEUREN UNI-COLOURS UNI FARBEN COLORIS UNI

Kleurcode U

romp wit; deuren in een Pfeiderer
Uni Kleur inclusief kantband in dezelfde
kleur. (ca. 80 varianten)

Kleuren: www.van-esch.com

Colourcode U

body white; doors in a Pfeiderer
Uni-colour including edging in the
same colour. (approx. 80 finishes)

Colours: www.van-esch.com

Farbkode U

Korpus weiß; Türen in eine Pfeiderer
Uni-Farbe einschließlich gleichfarbiger
Kanten. (ungefähr 80 Varianten)

Farben: www.van-esch.com

Code coloris U

corps blanc; portes en une Pfeiderer
Coloris Uni y-compris bande de chant
dans la même finition. (environ 80
finitions)

Couleurs: www.van-esch.com

Body



97/85

Doors + Panels



SE2 Sneeuwwit Str. MP	U1027 Ijswit Str. VV	U102 Krijtwit Str. VV	SR209 Edelwit Str. VV
-----------------------------	----------------------------	-----------------------------	-----------------------------



U130 Beige Str. MP	U1010 Wit/grijs Str. MP	U035 Parelgrijs Str. MP	U1131 Zilvergrijs Str. MP
--------------------------	-------------------------------	-------------------------------	---------------------------------



U1806 Dennengroen Str. MP	U110 Iguana Str. MP	U194 Zinkgeel Str. MP	U1559 Pastelgeel Str. MP
---------------------------------	---------------------------	-----------------------------	--------------------------------



U1508 Milano geel Str. VV	U032 Oranje Str. MP	U1667 Oranje Str. MP	U1665 Sinaasappel Str. VV
---------------------------------	---------------------------	----------------------------	---------------------------------



U1691 Robijnrood Str. VV	U225 Signaalrood Str. MP	U230 Licht Vanille Str. MP	U1379 Magnoliawit Str. MP
--------------------------------	--------------------------------	----------------------------------	---------------------------------



U133 Kieselgrijs Str. MP	U087 Magma Str. MP	U1184 Zandgrijs Str. MP	U1191 Congo Str. VV
--------------------------------	--------------------------	-------------------------------	---------------------------



U179 Cuba libre Str. VV	U182 Donkerbruin Str. MP	U1102 Truffelgrijs Str. VV	U092 Zonda grijs Str. MP
-------------------------------	--------------------------------	----------------------------------	--------------------------------



U018 Basaltgrijs Str. MP	U1257 Grafietgrijs Str. MP	U506 Antraciet metallic Str. MP	F8595 Grijs antraciet Str. MP
--------------------------------	----------------------------------	---------------------------------------	-------------------------------------



U074 Atlantic Str. MP	U079 Pacific Str. MP	U1739 Kristalblauw Str. MP	U1747 Donkerblauw Str. MP
-----------------------------	----------------------------	----------------------------------	---------------------------------



U057 Marineblauw Str. MP	U141 Orchidee Str. MP	U1200 Vulkaanzwart Str. MP/VV	U007 Grafietzwart Str. MP
--------------------------------	-----------------------------	-------------------------------------	---------------------------------



U501 Champagne metallic Str. MP	W410 Dekkend wit Str. MP	Span 140 Industrie wit Str. MP/SM	U1011 Vulkaanwit Str. MP	U197 Ivoor Str. MP
---------------------------------------	--------------------------------	---	--------------------------------	--------------------------



U1188 Lichtgrijs Str. MP	U1179 Manhattan grijs Str. MP	SR 204 Manhattan grijs Str. MP	U107 Avocado Str. MP	U1365 Camee Str. MP
--------------------------------	-------------------------------------	--------------------------------------	----------------------------	---------------------------



U116 Vanille Str. MP	U115 Bremgeel Str. MP	U1579 Eigeel Str. MP	U1574 Fluweelgeel Str. MP	U192 Zonnebloemgeel Str. MP
----------------------------	-----------------------------	----------------------------	---------------------------------	-----------------------------------



U246 Mango Str. MP	U054 Bourgondisch rood Str. MP	U031 Bordeaux Str. MP	U027 Wijnrood Str. MP
--------------------------	--------------------------------------	-----------------------------	-----------------------------



U184 Crème Str. MP	U1343 Zand Str. VV	U1303 Ivoorwit Str. VV	U1331 Beige/grijs Str. MP
--------------------------	--------------------------	------------------------------	---------------------------------



U1193 Quando Str. VV	U089 Fango Str. MP	U1980 Terrabruin Str. MP	U1349 Caramel Str. MP
----------------------------	--------------------------	--------------------------------	-----------------------------



U1211 Lava Str. MP	U1983 Coco Str. VV	U090 Bora grijs Str. MP	U091 Sharki Str. MP
--------------------------	--------------------------	-------------------------------	---------------------------



U1115 Platinagrijs Str. MP	U010 Platinagrijs Str. MP	U508 Grijs metallic Str. MP	F8582 Wit aluminium Str. MP	MP MiniPerl
----------------------------------	---------------------------------	-----------------------------------	-----------------------------------	----------------



U059 Gentiaanblauw Str. MP	U068 Hemelsblauw Str. MP	U1715 Hemelsblauw Str. MP	U056 Royal blue Str. MP	VV Top Velvet
----------------------------------	--------------------------------	---------------------------------	-------------------------------	------------------



U011 Vulkaan grijs Str. MP	U1233 Metaalzwart Str. MP	U231 Leisteengrijs Str. MP	U1290 Antracietgrijs Str. MP	SM Zijdemat/Satin
----------------------------------	---------------------------------	----------------------------------	------------------------------------	----------------------

Textures

HOUT DECORS WOOD DECORS HOLZDEKORE DÉCORS BOIS

Kleurcode HD

romp wit, deuren in een Pfeleiderer
Hout Decors inclusief kantband in
dezelfde kleur. (ca. 80 varianten)
Kleuren: www.van-esch.com

Colourcode HD

body white; doors in a Pfeleiderer Wood
Decor including edging in the same
colour. (approx. 80 finishes)
Colours: www.van-esch.com

Farbkode HD

Korpus weiß; Türen in eine Pfeleiderer
Holz Dekor einschließlich gleichfarbiger
Kanten. (ungefähr 80 Varianten)
Farben: www.van-esch.com

Code coloris HD

corps blanc; portes en une Pfeleiderer
Décor Bois y-compris bande de chant
dans la même finition. (environ 80
finitions)
Couleurs: www.van-esch.com

Body



97/85

Doors + Panels

Textures

vanEsch
AQUARIUS S
design van Esch Team, The Netherlands



AQUARIUS S

Bij de metalen Aquarius kasten ligt de nadruk op functie. Onnodige franjes ontbreken. Evengoed is het programma veelzijdig. De kasten zijn leverbaar met plint, onderstel of in combinatie met een zitbank, als garderobekast, maar ook als postvak. En met of zonder slot. Het uitgebreide programma is verkrijgbaar in ruim twintig standaard RAL-kleuren.

With the metal Aquarius the emphasis is on function. The versatility of the programme lies in its simplicity. The lockers are available with plinth, on a frame or in combination with a bench, as a wardrobe but also as a pigeon hole. And with or without a lock. The comprehensive series is available in over twenty standard RAL colours.

Bei den Metallschränken der Reihe Aquarius liegt der Akzent auf der Funktion. Kein überflüssiger Schnickschnack. Dafür ein ausgesprochen vielseitiges Programm. Die Schränke sind mit Sockel, Untergestell oder in Verbindung mit einer Sitzbank, als Garderobenschrank, oder auch als Postfach-Variante lieferbar mit oder ohne Schloss. Das breit gefächerte Programm ist in gut zwanzig RAL-Farben erhältlich.

Avec les armoires métalliques Aquarius, l'accent est mis sur la fonctionnalité, sans apprêt. Ce programme est aussi très varié. Les armoires sont disponibles avec plinthe, piétement ou en combinaison avec un banc, comme armoire de vestiaire, mais aussi comme casier de courrier, avec ou sans serrure. Cette large gamme est disponible dans plus de vingt couleurs standard RAL.





224 VAN ESCH



225 VAN ESCH





AQUARIUS SG

SG2301/P
SG2401/P
SG2501/P



185 cm
72,8 inch

60 / 80 / 100 cm
23,6 / 31,5 / 39,4 inch

50 cm
19,7 inch



See reference pages 291 and 311

AQUARIUS SG

SG1301/P
SG1401/P
SG1501/P

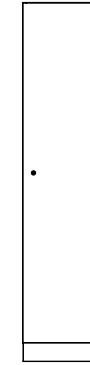

30 / 40 / 50 cm
11,8 / 15,7 / 19,7 inch

SG2301/P
SG2401/P
SG2501/P

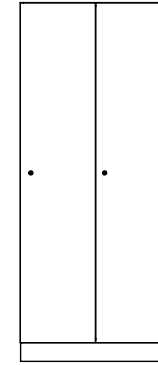

60 / 80 / 100 cm
23,6 / 31,5 / 39,4 inch

SG3301/P
SG3401/P

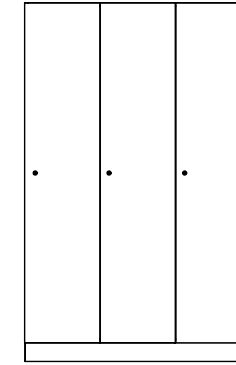

90 / 120 cm
35,4 / 47,2 inch

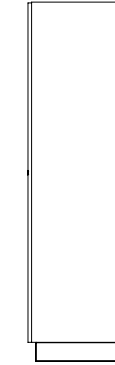

50 cm
19,7 inch

185 cm
72,8 inch

SG1301/O
SG1401/O
SG1501/O

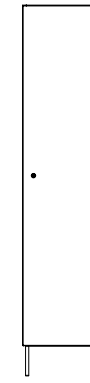

30 / 40 / 50 cm
11,8 / 15,7 / 19,7 inch

SG2301/O
SG2401/O
SG2501/O

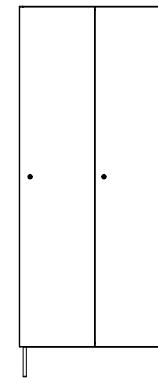

60 / 80 / 100 cm
23,6 / 31,5 / 39,4 inch

SG3301/O
SG3401/O

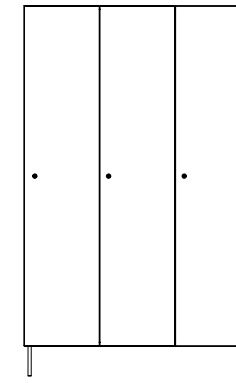

90 / 120 cm
35,4 / 47,2 inch



50 cm
19,7 inch

200 cm
78,7 inch

SG1301/OB
SG1401/OB
SG1501/OB

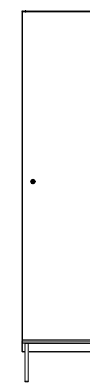

30 / 40 / 50 cm
11,8 / 15,7 / 19,7 inch

SG2301/OB
SG2401/OB
SG2501/OB

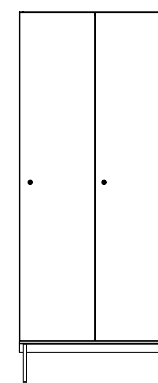

60 / 80 / 100 cm
23,6 / 31,5 / 39,4 inch

SG3301/OB
SG3401/OB

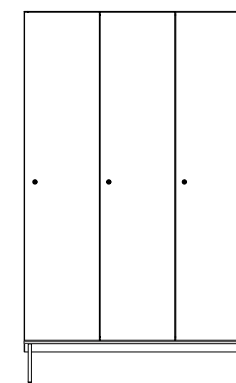

90 / 120 cm
35,4 / 47,2 inch

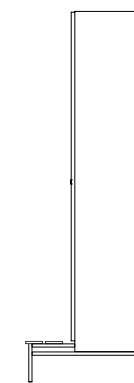

80 cm
31,5 inch

200 cm
78,7 inch

AQUARIUS SG

SG1302/P
SG1402/P

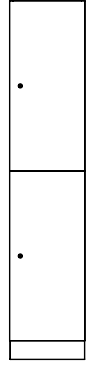

30 / 40 cm
11,8 / 15,7 inch

SG2302/P
SG2402/P

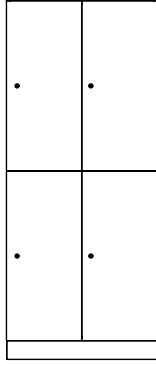

60 / 80 cm
23,6 / 31,5 inch

SG3302/P
SG3402/P

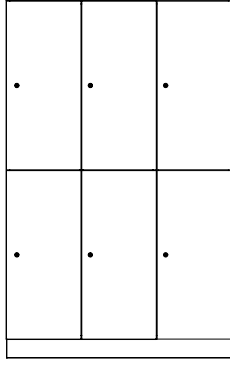

90 / 120 cm
35,4 / 47,2 inch

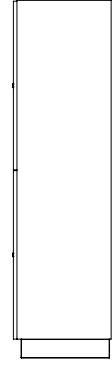

50 cm
19,7 inch

185 cm
72,8 inch

SG1302/O
SG1402/O

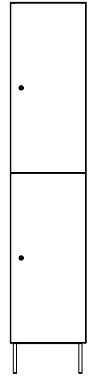

30 / 40 cm
11,8 / 15,7 inch

SG2302/O
SG2402/O

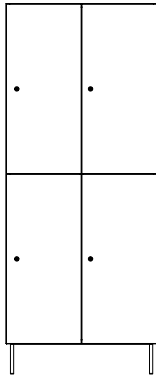

60 / 80 cm
23,6 / 31,5 inch

SG3302/O
SG3402/O

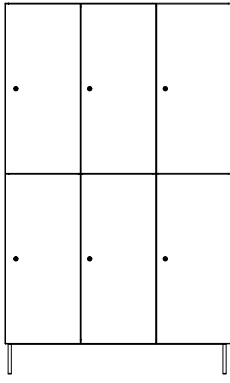

90 / 120 cm
35,4 / 47,2 inch

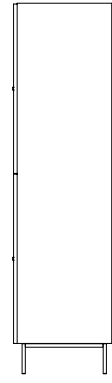

50 cm
19,7 inch

200 cm
78,7 inch

SG1302/OB
SG1402/OB

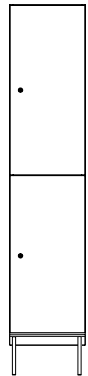

30 / 40 cm
11,8 / 15,7 inch

SG2302/OB
SG2402/OB

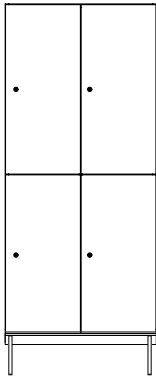

60 / 80 cm
23,6 / 31,5 inch

SG3302/OB
SG3402/OB

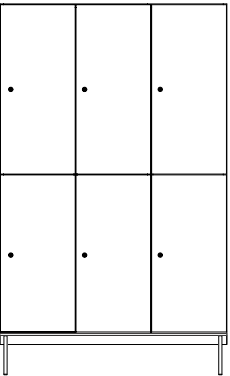

90 / 120 cm
35,4 / 47,2 inch

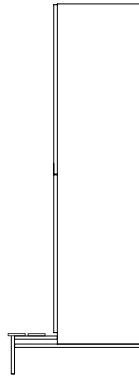

80 cm
31,5 inch

200 cm
78,7 inch

AQUARIUS SZ

SZ3402/P

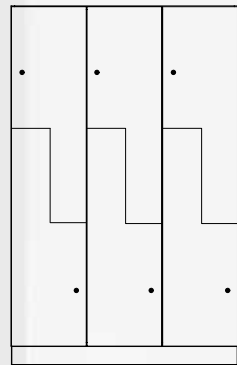

185 cm
72,8 inch

120 cm
47,2 inch



185 cm
72,8 inch

50 cm
19,7 inch



AQUARIUS SZ

SZ1402/P
SZ1502/P

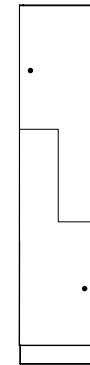

40 / 50 cm
15,7 / 19,7 inch

SZ2402/P
SZ2502/P

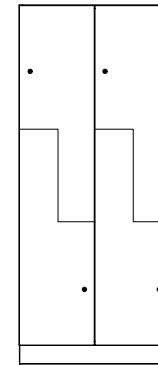

80 / 100 cm
31,5 / 39,4 inch

SZ3402/P

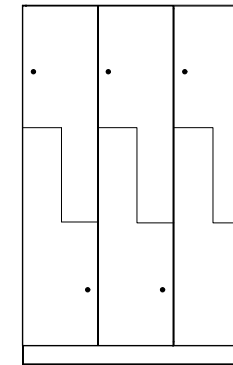

120 cm
47,2 inch

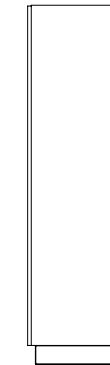

185 cm
72,8 inch

SZ1402/O
SZ1502/O

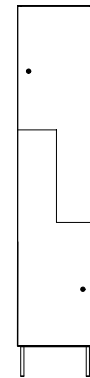

40 / 50 cm
15,7 / 19,7 inch

SZ2402/O
SZ2502/O

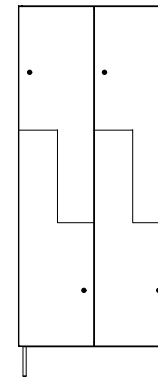

80 / 100 cm
31,5 / 39,4 inch

SZ3402/O

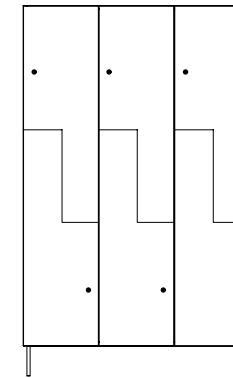

120 cm
47,2 inch

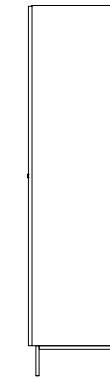

200 cm
78,7 inch

SZ1402/OB
SZ1502/OB

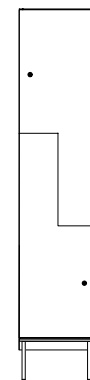

40 / 50 cm
15,7 / 19,7 inch

SZ2402/OB
SZ2502/OB

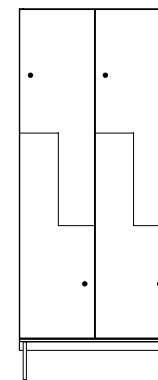

80 / 100 cm
31,5 / 39,4 inch

SZ3402/OB

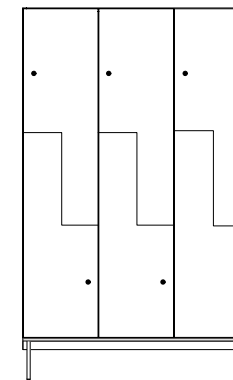

120 cm
147,2 inch

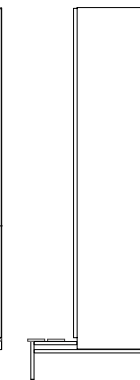

80 cm
31,5 inch

200 cm
78,7 inch

AQUARIUS SV

SV1305/P
SV1405/P

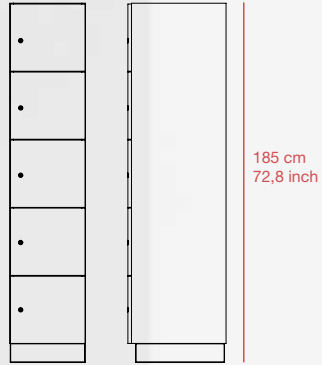

30 / 40 cm 50 cm
11,8 / 15,7 inch 19,7 inch



AQUARIUS SV

SV1303/P
SV1403/P

SV1304/P
SV1404/P

SV1305/P
SV1405/P

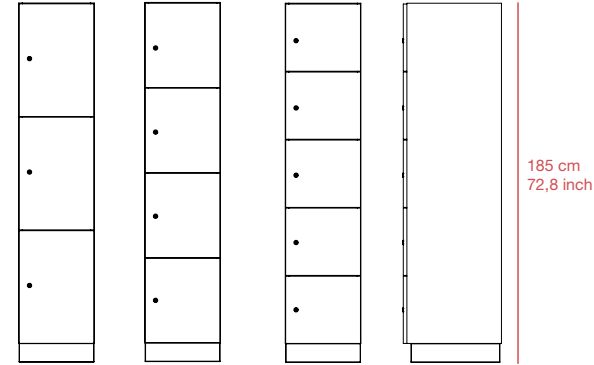

30 / 40 cm 30 / 40 cm 30 / 40 cm 50 cm
11,8 / 15,7 inch 11,8 / 15,7 inch 11,8 / 15,7 inch 19,7 inch

SV2303/P
SV2403/P

SV2304/P
SV2404/P

SV2305/P
SV2405/P

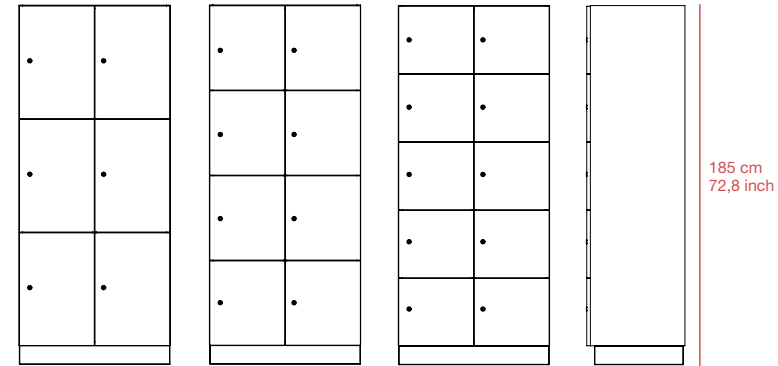

60 / 80 cm 60 / 80 cm 60 / 80 cm 50 cm
23,6 / 31,5 inch 23,6 / 31,5 inch 23,6 / 31,5 inch 19,7 inch

SV3303/P
SV3403/P

SV3304/P
SV3404/P

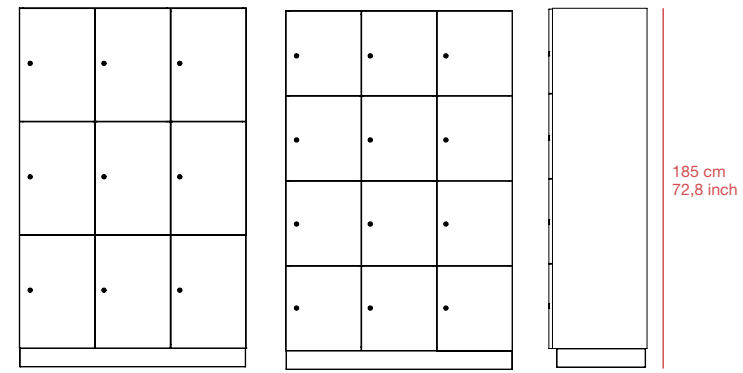

90 / 120 cm 90 / 120 cm 50 cm
35,4 / 47,2 inch 35,4 / 47,2 inch 19,7 inch

AQUARIUS SP

SP1306

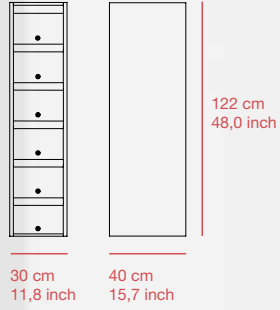

AQUARIUS SP

SP1305

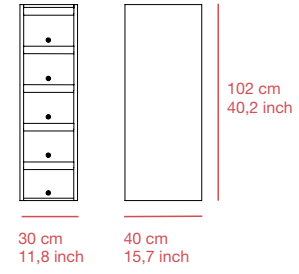

SP1306

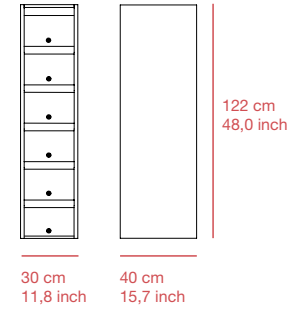

AQUARIUS S ACCESSORIES



S/CS cylinder lock



S/MS coin lock



S/PCS LS100 pin code lock



S/PCS Mauer pin code lock



S/HV padlock provision



NP number tag



NH1 name plate holder



NH2 name plate holder



NH3 name plate holder



NH4 number tag



NH4 number tag



NH5 card holder



SN key number tag



S/PN number tag

STANDAARD KLEUREN STANDARD COLOURS STANDARDFARBEN COLORIS STANDARD

Locker



RAL 0030
*SP excluded

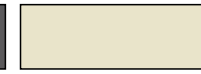

RAL 1013



RAL 1015



RAL 1017



RAL 2002



RAL 3002



RAL 5002



RAL 5010



RAL 5012



RAL 5014



RAL 6011



RAL 6019



RAL 6021



RAL 7016



RAL 7032



RAL 7035



RAL 7040

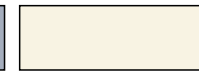

RAL 9001

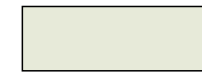

RAL 9002



RAL 9005



RAL 9006



RAL 9010

Frame



RAL 0030

Seat parts



Deal

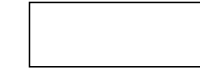

White plastic



OCLOCK

De vorm van de door architect Anthony Duffeleer ontworpen klok Oclock is een gevolg van het productieproces, namelijk rotatiegieten. Daarbij gaat kunststof poeder in een mal. Die wordt vervolgens in een oven geplatst en gerooteerd. De kunststof hecht zich aan de wand en krijgt zo zijn uiteindelijke vorm. Voordeel van dit proces is dat de klok ondanks de royale afmetingen toch licht van gewicht is.

The shape of the clock Oclock designed by architect Anthony Duffeleer is due to its rotation casting production process. In this process plastic powder goes in a mould, which is then placed in an oven and rotated. The plastic adheres to the wall and in this way takes on its final shape. A benefit of this process is that despite its generous dimensions the clock is nonetheless light in weight.

Die Form der vom Architekten Anthony Duffeleer entworfenen Uhr ergibt sich aus dem Produktionsverfahren, nämlich dem Rotationsguss. Dabei wird Kunststoffpuder in eine Form gestreut. Diese wird anschließend in einen Ofen gestellt und rotiert. Der Kunststoff haftet an der Wand und erhält auf diese Weise seine definitive Form. Der Vorteil dieses Verfahrens ist, dass die Uhr trotz ihres großzügigen Umfangs ein Leichtgewicht ist.

La forme de cette horloge créée par l'architecte Anthony Duffeleer, est la conséquence du processus de fabrication, c'est-à-dire le moulage par rotation. Dans ce procédé, la poudre de thermoplastique est versée dans un moule. Ce moule est placé dans un four et mis en rotation. Le plastique se fixe à la paroi du moule ce qui produit la forme finale. L'avantage de ce procédé est que malgré ses dimensions généreuses, l'horloge reste légère.





OCLOCK

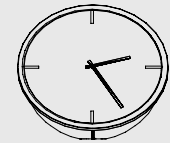

115 cm
45,3 inch

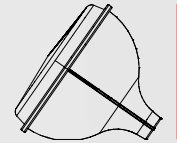

98 cm
38,6 inch

105 cm
41,3 inch

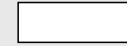

White



vanEsch

SOFT TABLES

design Gilberte Claes, Belgium



SOFT TABLES

Waar bedrijvigheid heerst, is behoefte aan rust. Daarin voorzien de Soft Tables van de Vlaamse designer Gilberte Claes. Dankzij hun elementaire uiterlijk zijn ze uiterst functioneel. Des te opvallender is de rijke detaillering. Zo zijn het blad en de zachte bovenlaag bewust zichtbaar verlijmd. De bijzet-tafels bestaan uit drie elementen: een gepolijste of geëpoxeerde voetplaat, een rondstalen poot van geschuurd roestvast of geëpoxeerd staal en een blad met desktop. Soft Tables zijn verkrijgbaar in verschillende kleuren, hoogtes en diameters.

Where there is activity there is always a need for rest. The Soft Tables of Flemish designer Gilberte Claes provide this. Thanks to their elementary appearance they are highly functional. This makes the rich details even more eye-catching. The top and soft upper layer, for example, have been visibly glued together on purpose. The side tables consist of three elements: a polished or epoxy coated base plate, a round steel leg of brushed stainless steel or epoxy coated steel and a top with desktop. Soft Tables are available in various colours, heights and diameters.

Wo viel Betrieb herrscht, besteht auch ein Bedürfnis nach Ruhe. Dies bieten die Soft Tables der flämischen Designerin Gilberte Claes. Dank ihrem auf das Wesentliche reduzierten Design sind sie äußerst funktionell, die reichen Details sind deshalb umso auffallender. Die Tischplatte und die weiche oberste Schicht wurden bewusst sichtbar miteinander verleimt. Die Beistelltische bestehen aus drei Elementen: einer polierten oder epoxierten Fußplatte, einer Rundstahlsäule aus gebürstetem Edelstahl oder epoxiertem Stahl und einer Tischplatte mit Desktop. Die Soft Tables sind in verschiedenen Farben, Höhen und Durchmessern erhältlich.

Là où règne l'animation, le besoin de calme se fait sentir. C'est ce qu'expriment les tables Soft de la styliste flamande Gilberte Claes. Leur apparence élémentaire les rend extrêmement fonctionnelles. Les détails n'en sont que plus remarquables. Ainsi, le plateau et la couche supérieure douce sont visiblement collés. Ces tables d'appoints sont constituées de trois éléments : une base polie et pourvue d'un revêtement époxyde, un pied rond en acier inoxydable frotté ou en acier avec revêtement époxyde et un plateau avec revêtement desktop. Les tables Soft sont disponibles dans différentes couleurs et hauteurs et différents diamètres.





SOFT TABLES CT5057

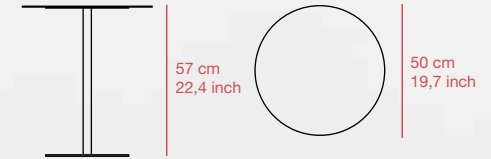

Top Base and column



4175

RAL 7030



4023

RAL 9011



4164

RAL 3011

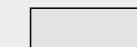

INOX

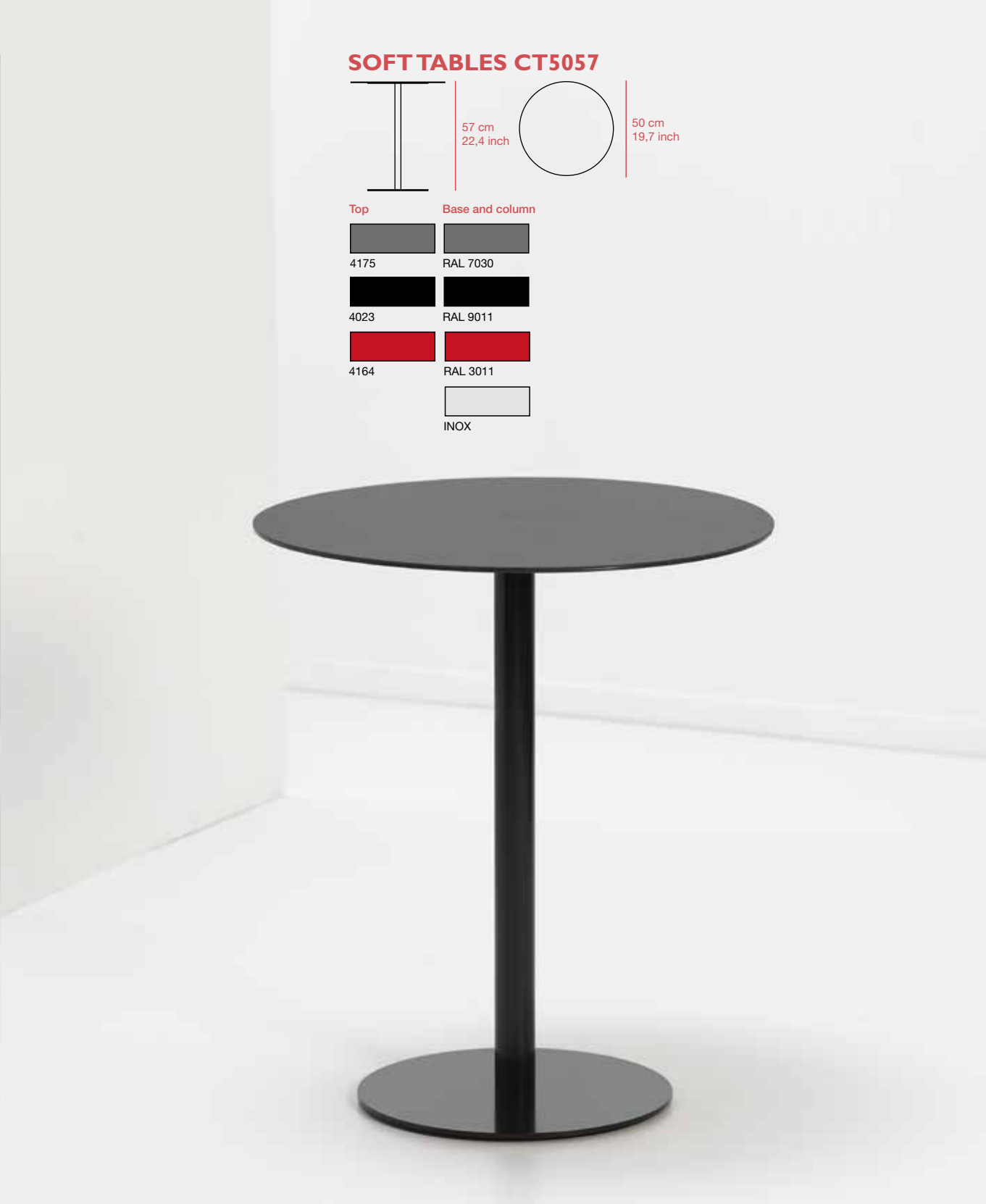

SOFT TABLES CT5043

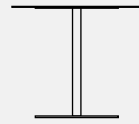

43 cm
16,9 inch

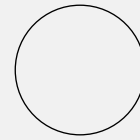

50 cm
19,7 inch

Top



4175

Base and column



RAL 7030



4023



RAL 9011



4164



RAL 3011



INOX



SOFT TABLES CT7043

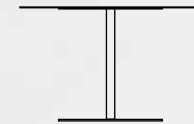

43 cm
16,9 inch

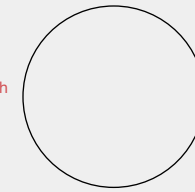

70 cm
27,6 inch

Top



4175

Base and column



RAL 7030



4023



RAL 9011



4164



RAL 3011

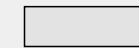

INOX





CIRCUS

Sleutels of post worden vaak zomaar ergens neergegoid. Dat hoeft niet meer. De oplossing heet Circus. Door de haakjes en ringen biedt het ontwerp van Roderick Vos tal van opbergmogelijkheden. Deze opvallende wandkapstok is gemaakt van geëpoxeerd staal en verkrijgbaar in meerdere kleuren.

Keys or mail are often just thrown down anywhere. This no longer has to be the case. The solution is called Circus. The hooks and rings on Roderick Vos's design offer plenty of storage possibilities. This striking wall coat rack is made from epoxy coated steel and is available in various colours.

Schlüssel oder Post werden meist irgendwo hingeworfen. Das muss nicht mehr sein. Die Lösung heißt Circus. Dank der Haken und Ringe bietet der Entwurf von Roderick Vos vielfältige Aufbewahrungsmöglichkeiten. Diese auffallende Wandgarderobe besteht aus epoxiertem Stahlblech und ist in mehreren Farben erhältlich.

Clés ou courrier son souvent déposés un peu n'importe où. Ce n'est plus nécessaire. La solution s'appelle Circus. Les crochets et les anneaux de cette création de Roderick Vos offrent de multiples possibilités de rangement. Ce portemanteau mural remarquable est réalisé en acier avec revêtement époxyde et est disponible dans plusieurs couleurs.







CIRCUS

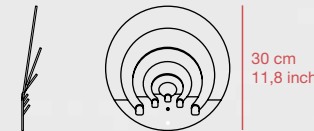

4,5 cm
1,8 inch

30 cm
11,8 inch



RAL 9011

RAL 9006



RAL 9010

RAL 3002



RAL 2004

RAL 6018

vanEsch

TREE HOOKED

design Alissia Melka-Teichroew & Jan Habraken, USA



TREE HOOKED

Voor het ontwerp van Tree Hooked lieten designers Alissia Melka-Teichroew en Jan Habraken zich inspireren door een bloemenpatroon dat ze tijdens een reis door Europa ergens op een muur zagen. Door meerdere exemplaren van de laser-gesneden wandkapstok bij elkaar te plaatsen ontstaat een mooi beeld op de wand. Tree Hooked is verkrijgbaar in meerdere kleuren.

For the design of Tree Hooked, designers Alissia Melka-Teichroew and Jan Habraken were inspired by a flower pattern they had seen on a wall somewhere during a trip through Europe. By mounting the laser-cut hooks alongside one another on the wall, some very attractive effects can be created. Tree Hooked is available in various colours.

Für den Entwurf von Tree Hooked ließen sich die Designer Alissia Melka-Teichroew und Jan Habraken von einem Blumenmuster inspirieren, das sie auf einer Reise durch Europa irgendwo auf einer Mauer gesehen haben. Werden mehrere Exemplare der lasergeschnittenen Wandgarderobe miteinander verbunden, entsteht ein schönes Bild auf der Wand. Tree Hooked ist in verschiedenen Farben erhältlich.

Pour la création de Tree Hooked, les stylistes Alissia Melka-Teichroew et Jan Habraken se sont inspirés d'un motif de fleurs découvert quelque part sur un mur au cours d'un voyage en Europe. Plusieurs exemplaires sur un mur de ce portemanteau coupé au laser constituent une belle sculpture murale. Tree Hooked est disponible dans diverses couleurs.





TREE HOOKED

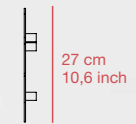
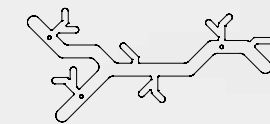

59 cm
23,2 inch

27 cm
10,6 inch

3 cm
1,2 inch



RAL 9011

RAL 9006



RAL 9010

RAL 3002



RAL 6018

vanEsch

STICKS

design Mia Gammelgaard, Denmark & Ehlén Johansson, Sweden



STICKS

De kapstokkenreeks Sticks springt in het oog door de combinatie van kunststof en hout. Maar het idee achter de nieuwe familie is volgens ontwerpstere Mia Gammelgaard en Ehlén Johansson toch vooral opgehangen aan de kunststof haken. 'Hoe kunnen we die haken op verschillende manieren toepassen. Dat is de vraag die we onszelf gesteld hebben', verduidelijkt Gammelgaard. Door de kunststof haken op verschillende manieren te verwerken, zijn de ontwerpen in de serie in uiteenlopende situaties bruikbaar. Zo kunnen de kapstokken aan de muur bevestigd worden, maar ook een plaats in de ruimte krijgen.

What makes the Sticks series of coat stands so unique is the combination of plastic and wood. According to designers Mia Gammelgaard and Ehlén Johansson, however, the idea behind this new family of products is based above all on the plastic hooks. 'How can the same hooks be used in different ways? That is the question we put to ourselves,' explained Gammelgaard. By using the plastic hooks in a number of different ways, the designs in this series are suitable for use in a range of situations. The coat racks can for example be attached to the wall, or be used as a free-standing element.

Durch die Kombination von Kunststoff und Holz ist die Garderobenserie Sticks ein echter Hingucker. Aber die Idee, die der neuen Familie zugrunde liegt, hängt doch in erster Linie mit den Kunststoff-Haken zusammen, wie die Designerinnen Mia Gammelgaard und Ehlén Johansson erläutern. 'Wie können wir diese Haken auf verschiedene Weisen anwenden? Das ist die Frage, die wir uns selbst gestellt haben', erklärt Gammelgaard. Durch eine verschiedenartige Verarbeitung der Kunststoff-Haken sind die Entwürfe dieser Serie in ganz unterschiedlichen Situationen brauchbar. So können die Garderoben an der Wand befestigt werden, aber auch im Raum platziert werden.

La série des portemanteaux Sticks attire tous les regards par sa symbiose de plastique et de bois. Mais l'idée qui sous-tend cette nouvelle famille porte sur les crochets en plastique, selon les designers Mia Gammelgaard et Ehlén Johansson. « Comment renouveler et décliner le concept des crochets ? C'est la question que nous nous sommes posées », explique Gammelgaard. Les articles de la série conviennent à des situations très diverses grâce à la façon dont les crochets sont disposés. Les portemanteaux se fixent au mur, mais peuvent aussi se placer à même le sol.







STICKS ROUND

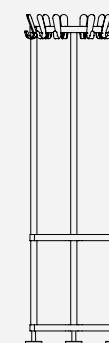

170 cm
66,9 inch

46,5 cm
18,3 inch

Hooks



White plastic

Column



Oak

Crown, umbrella holder and base



vE 9310

STICKS G+

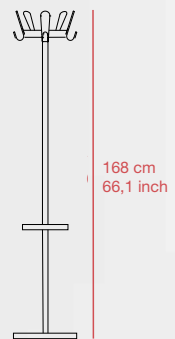

35 cm
13,8 inch

Hooks



White plastic

Column



Oak

Crown, umbrella holder and base



VE 9310



STICKS HJH

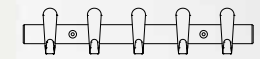

30 - 60 - 90 cm
11,8 - 23,6 - 35,4 inch

Hooks



White plastic

Profile



Oak



12,5 cm
4,9 inch

7,5 cm
3,0 inch

vanEsch

SLIDE

design DUMoffice, The Netherlands



SLIDE

Het idee achter Slide is eenvoudig. Het ontwerp bestaat uit twee metalen buizen die door ze in of uit elkaar te schuiven tussen vloer en plafond geklemd kunnen worden tot een plafondhoogte van 340 cm. De buizen zijn voorzien van een aantal verstevigde kunststof haken die op verschillende hoogtes kunnen worden bevestigd, zodat er bijvoorbeeld ook kinderjassen kunnen worden opgehangen. In de eenvoud schuilt tevens de kracht van het ontwerp: de vorm zegt alles over de functie.

The idea behind Slide is simple. The design consists of two metal tubes that can be fixed into position between floor and ceiling (up to 340 cm) by sliding them in and out of one another. The tubes are fitted with a series of strengthened plastic hooks that can be attached at various heights so it can also be used for children. This very simplicity is also the strength of the design, whereby the form says everything about the function.

Die Idee, die Slide zugrunde liegt, ist ganz einfach. Der Entwurf besteht aus zwei Metallrohren, die durch Ineinander- bzw. Auseinander schieben zwischen Boden und Decke (bis zu 340 cm) geklemmt werden können. Die Rohre sind mit einer Reihe von verstärkten Kunststoff-Haken versehen, die sich in verschiedenen Höhen befestigen lassen so dass die zum Beispiel auch für Kinderjacke benutzt werden kann. Gerade in seiner Schlichtheit steckt auch die Kraft dieses Entwurfs: die Form sagt bereits alles über die Funktion.

Le concept à l'origine de Slide est simple. Il se compose de deux tubes métalliques qui, par un système de coulissement, se calent entre le sol et le plafond (jusqu'au un plafond de 340 cm). Ils sont dotés de plusieurs crochets renforcés en plastique qui se fixent à diverses hauteurs, cela pour-quoi il est aussi possible de placer des manteaux pour des enfants. La force du concept réside dans sa simplicité; la forme évoque la fonction.





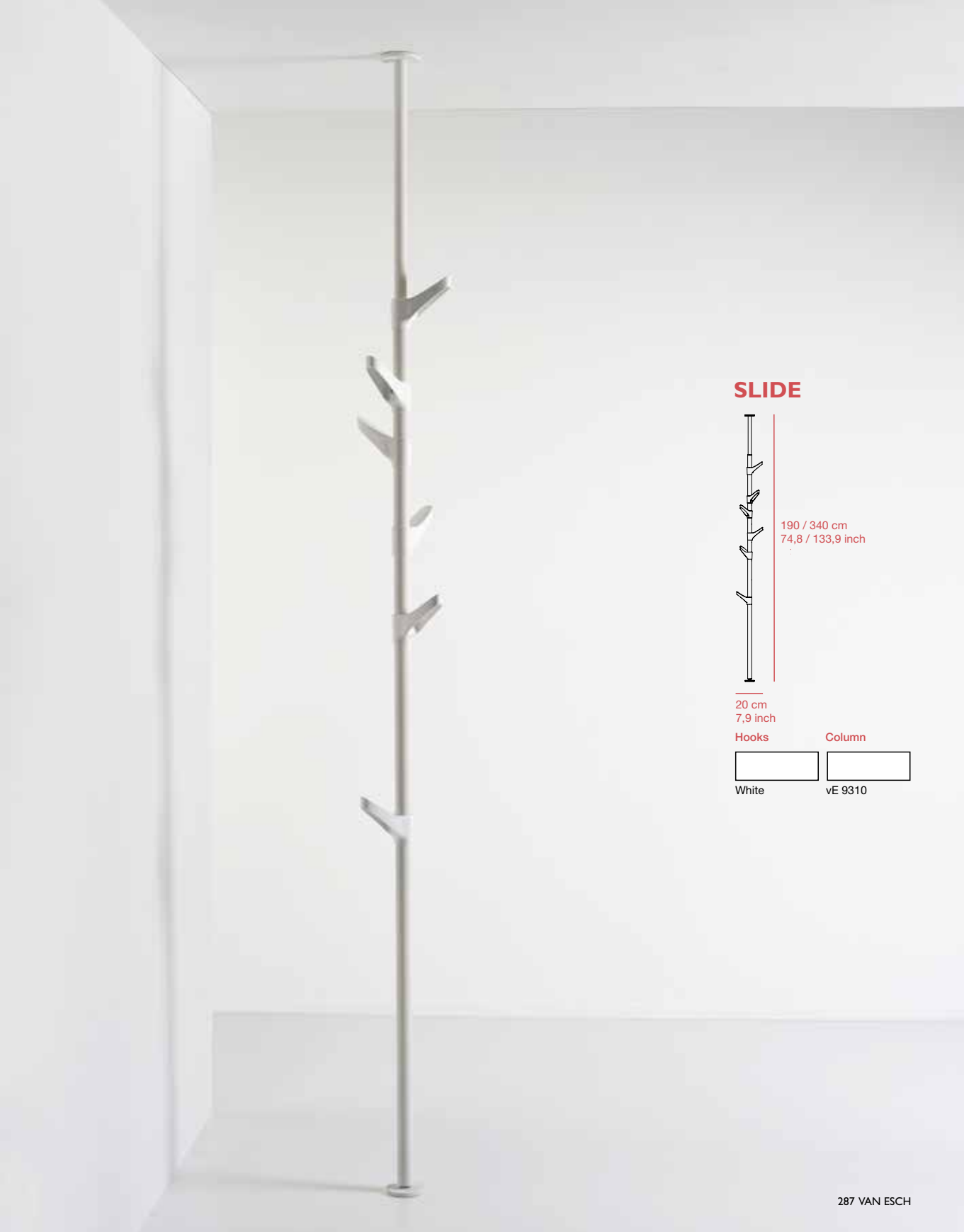

SLIDE

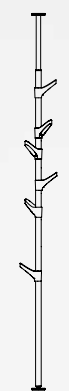

190 / 340 cm
74,8 / 133,9 inch

20 cm
7,9 inch

Hooks

Column



White



vE 9310

REFERENTIES REFERENCES REFERENZEN RÉFÉRENCES

RIJKSMUSEUM AMSTERDAM 291
BERNHOVEN HOSPITAL UDEN 297
BUREAU JEUGDZORG AMSTERDAM 301
INDICIA TILBURG 307
RABOBANK HEAD OFFICE UTRECHT 311
EUROMEX HEAD OFFICE EDEGEM 319

REFERENCE LIST 323

RIJKSMUSEUM AMSTERDAM

RIJKSMUSEUM

Met een spraakmakende ingreep legde architectenbureau Cruz y Ortiz het oorspronkelijke karakter van het Rijksmuseum in Amsterdam bloot. Evengoed is het interieur van deze tijd. Zo is de garderobe met kapstokken, houten kasten en parapluerekken volledig op maat gemaakt. Zelfs de kleeuhangers zijn voor dit project ontwikkeld. In de kleedruimte is gekozen voor stalen kasten met pincodesloten.

Architect's firm Cruz y Ortiz's much talked about re-design of the Rijksmuseum reveals the Amsterdam museum's original character. The interior nonetheless retains a contemporary feel. The cloakroom, for example, with all its coat stands, wooden lockers and umbrella stands, has been fully tailor made. Even the coat hangers were specially designed for this project. The changing rooms are equipped with steel lockers with pin code locks.

Mit einem aufsehenerregenden Eingriff hat das Architekturbüro Cruz Y Ortiz den ursprünglichen Charakter des Rijksmuseums in Amsterdam wiederhergestellt. Die Inneneinrichtung ist allerdings modern und zeitgemäß. Die Garderobe mit Kleiderablagen, Holzschränken und Schirmständern ist eine maßgeschneiderte Lösung. Selbst die Kleiderbügel wurden speziell für dieses Projekt neu entwickelt. In den Umkleieräumen wurden Stahlschränke mit Codeschlössern verwendet.

Par une intervention retentissante, le cabinet d'architectes Cruz y Ortiz a mis à nu le caractère original du Rijksmuseum d'Amsterdam. L'intérieur est cependant contemporain. Le vestiaire et ses portemanteaux, armoires en bois et râteliers à parapluies ont été fabriqués sur mesure. Même les cintres ont été spécialement conçus pour ce projet. Dans les vestiaires, des armoires en acier avec serrures à code confidentiel ont été choisies.







BERNHOFEN HOSPITAL UDEN

BERNHOFEN HOSPITAL

Ziekenhuis Bernhoven in Uden voldoet volledig aan de eisen van deze tijd. Het gebouw heeft een warme, bijna persoonlijke uitstraling waardoor zowel patiënten als personeel er zich op hun gemak voelen. De banken, de hakenprofielen en houten lockers, die zijn toegepast in de heren- en dameskleedkamers, sluiten daarbij perfect aan.

Bernhoven hospital in Uden fully meets all the requirements of the modern age. The building has a warm, almost personal feel, making patients and staff alike feel completely at home. The benches, hooks and wooden lockers that have been fitted in the men's and ladies' changing rooms are fully in keeping with this.

Das Krankenhaus Bernhoven in Uden entspricht vollständig den Anforderungen unserer Zeit. Das Gebäude verfügt über eine warme, fast persönliche Ausstrahlung, wodurch sich die Patienten wie auch das Personal wohlfühlen. Die Bänke, Hakenprofile und Holzschränke, die sich in den Herren- und Damen-Umkleideräumen befinden, passen hervorragend dazu.

L'hôpital Bernhoven à Uden répond entièrement aux normes de notre époque. Le bâtiment à un aspect chaleureux, presque intime, qui fait que les patients et le personnel s'y sentent à l'aise. Les bancs, les barres de patères et les casiers en bois, utilisés dans les vestiaires hommes et femmes, contribuent à cette ambiance.





298 VAN ESCH



299 VAN ESCH

BUREAU JEUGDZORG AMSTERDAM

BUREAU JEUGDZORG

Bureau Jeugdzorg gaat uit van de rechten van het kind op een veilige opvoeding. In de kantoorruimtes is gekozen voor vakkenkasten met een houtdecor. Ze accentueren de warme uitstraling van de werkrumtes. De kasten zijn voorzien van pincodesloten.

The Youth Care Office is dedicated to the right of children to have a safe upbringing. The offices have been equipped with lockers with a wood effect, which accentuate the warm feel of the work areas. The lockers have been fitted with pin code locks.

Das Bureau Jeugdzorg vertritt die Rechte zum Schutz von Kindern und Jugendlichen. Für die Büroräume wurden Fächerschränke in Holzoptik ausgewählt. Sie betonen die warme Ausstrahlung der Arbeitsräume. Die Schränke sind mit Codeschlössern ausgerüstet.

Le bureau d'aide sociale à la jeunesse d'Amsterdam base son action sur les droits de l'enfant à une éducation en sécurité. Les espaces de bureaux ont été aménagés avec des armoires de casiers avec décor en bois. Elles accentuent l'ambiance chaleureuse des espaces de travail. Les armoires sont pourvues de serrures à code confidentiel.



1090
-
1173



INDICIA TILBURG

INDICIA

Het Tilburgse bedrijf Indicia richt zich op de ontwikkeling van onder meer apps, sites, portals en social media. Gebruiksvriendelijkheid is een tweede natuur. Dat is ook af te lezen aan de inrichting van het kantoorpand aan de rand van het centrum. Daar komen de verschillende houten lockerkasten, Dodici garderobestandaards en bijpassende Drip paraplubakken dan ook uitstekend tot hun recht.

The Tilburg company Indicia specializes in developing, for example, apps, sites, portals and social media. User-friendliness is second nature. That can be clearly seen from the interior of the office that is located at the city centre's edge. Here the various wooden lockers, Dodici cloakroom stands and accompanying Drip umbrella stands look at their very best.

Das Unternehmen Indicia in Tilburg entwickelt Apps, Websites, Portale und Social-Media-Anwendungen. Benutzerfreundlichkeit ist fast seine zweite Natur. Das lässt sich auch an der Einrichtung des Bürogebäudes am Rand des Zentrums ablesen. Dort kommen die verschiedenen Holzschränke, die Dodici Garderobenstände und die dazu passenden Drip Schirmständer auch ausgezeichnet zur Geltung.

L'entreprise de Tilburg Indicia se consacre entre autres au développement d'applications, de sites et de portails et de médias sociaux. La facilité d'utilisation est une seconde nature. Cela se constate à l'aménagement de l'immeuble de bureaux aux abords du centre ville. Les différents casiers en bois, les portemanteaux Dodici et les bacs à parapluies Drip y sont parfaitement à leur place.





RABOBANK HEAD OFFICE UTRECHT

RABOBANK HEAD OFFICE

In het door architectenbureau Kraaijvanger ontworpen hoofdkantoor van de Rabobank in Utrecht is gekozen voor een nieuwe manier van werken. In het transparante interieur vinden klanten en medewerkers intuïtief de weg. De speels vormgegeven wandkapstok Wings, evenals de garderobebanken en stalen kasten zijn er op hun plaats. Ze zijn te vinden in kleedruimtes en fietsenstalling.

At the Rabobank head office in Utrecht, designed by architect's firm Kraaijvanger, a new form of working has been adopted. In the transparent interior customers and staff intuitively find their way around. The whimsical design of the Wings coat rack, as well as the cloakroom benches and steel lockers, fit in with this style. They can be found in the changing rooms and bike sheds.

Im vom Architekturbüro Kraaijvanger entworfenen Hauptsitz der Rabobank in Utrecht hat man sich für eine neue Arbeitsweise entschieden. Kunden und Mitarbeiter finden im transparenten Interieur intuitiv ihren Weg. Die spielerische Linienführung der Wandgarderobe Wings sowie auch die Garderobebänke und stahlschränke kommen hier ausgezeichnet zur Geltung. Sie sind in den Umkleieräumen und im Fahrradabstellraum zu finden.

Dans la conception du siège de la banque Rabobank, à Utrecht, le cabinet d'architectes Kraaijvanger a choisi d'utiliser une nouvelle manière de travailler. Dans l'intérieur transparent, les clients et les employés trouvent leur chemin intuitivement. Les portemanteaux muraux riches de fantaisie, ainsi que les bancs de vestiaires et les armoires en acier y sont parfaitement à leur place. Ils se trouvent dans les vestiaires et l'abri pour vélos.







Regenkleding



EUROMEX HEAD OFFICE

Slim, efficiënt en effectief. Het zijn de belangrijkste kenmerken van het nieuwe werken. Het is dan ook niet vreemd dat Vlaamse rechtsbijstandverzekeraar Euromex er bij de inrichting van het kantoorpand in Edegem voor heeft gekozen. In de open kantoorruimte zijn de houten lockers, die zijn voorzien van een garderobe-element, perfect op hun plaats. Ze dragen bij aan de intimiteit op de werkvloer, zonder afbreuk te doen aan het transparante karakter van de ruimte.

Smart, efficient and effective. These are the most important features of the new way of working. It therefore comes as no surprise that Flemish legal aid insurer Euromex has decided to furnish its offices in Edegem with these features in mind. The wooden lockers, which are fitted with a cloakroom element, fit in perfectly with the open plan office design. They help to add to the intimate feel in the office without detracting from the transparent character of the office space.

Intelligent, effizient und effektiv. Das sind die wichtigsten Merkmale der neuen flexiblen Arbeitswelt. Darum liegt es auch vor der Hand, dass der flämische Rechtsschutzversicherer Euromex bei der Einrichtung des Bürogebäudes in Edegem solchen Eigenschaften den Vorzug gegeben hat. Im offenen Büroraum wirken die Schränke aus Holz, die mit einem Garderobenelement kombiniert werden, wie perfekt für ihren Platz geschaffen. Sie tragen zur Privatsphäre am Arbeitsplatz bei, ohne die Transparenz der Linienführung zu beeinträchtigen.

Ingéniosité, efficacité et effectivité. Telles sont les principales caractéristiques de la nouvelle façon de travailler. Il n'est donc pas étrange que la compagnie flamande d'assurance de protection juridique Euromex ait basé son choix sur les mêmes principes pour l'aménagement de son siège à Edegem. Dans l'espace de bureau ouvert, les casiers en bois, qui sont équipés d'éléments de vestiaires, se trouvent parfaitement à leur place. Ils contribuent à l'intimité du lieu de travail, sans nuire au caractère transparent de l'espace.

vanEsch

EUROMEX HEAD OFFICE EDEGEM





REFERENTIES REFERENCES REFERENZEN RÉFÉRENCES

THE NETHERLANDS

Academisch Ziekenhuis Maastricht, Maastricht	Electrabel, Hoogeveen
Albert Heijn Hoofdkantoor, Zaandam	Elsevier, Den Haag
Albert Schweitzer Ziekenhuis, Dordrecht	Eneco, Breukelen
Alliander-Endinet, Eindhoven	Ernst & Young, Ede
Amsterdams Lyceum, Amsterdam	Essent, Roermond
Anton Jurgenshuis, Oss	Europol, Den Haag
Arbo Unie Zuid, Breda	FC Utrecht, Utrecht
ASML, Veldhoven	Fontys Hogeschool, Various locations
Astellas, Leiden	Fortis Bank, Various offices
Avans Hogeschool, Den Bosch	Frits Philips Museum, Eindhoven
AZ, Alkmaar	Gemeente Amersfoort, Amersfoort
Bavaria, Lieshout	Gemeente Amsterdam, Amsterdam
Bavo Europoort, Capelle aan den IJssel	Gemeente Ede, Ede
Belastingdienst, Arnhem, Zwolle	Gemeente Eindhoven, Eindhoven
Bernhoven ziekenhuis, Uden	Gemeente Haarlemmermeer, Hoofddorp
Bibliotheek Nijmegen, Nijmegen	Gemeente Utrechtse Heuvelrug, Doorn
Bovag, Bunnik	GGD Rivierland, Tiel
Brabant Water, Den Bosch	Go Ahead Eagles, Deventer
Brandweer, Various locations	Golfbaan Efteling, Kaatsheuvel
Bronovo Ziekenhuis, Den Haag	Groene Land Verzekeringen, Meppel
Bureau Jeugdzorg, Various locations	Grolsche Bierbrouwerij Nederland, Enschede
C1000, Dronten	Hardy's, Tilburg
Cambium College, Sint Oedenrode	HBG Civiel, Amsterdam
Chassé Theater, Breda	Heineken, Various locations
Concert- en gehoorzaal, Middelburg	HEMA, Amersfoort
Cultureel Centrum Elckerlyc, Hilvarenbeek	Hitachi, Zaltbommel
Cultureel Centrum Jan van Besouw, Goirle	Hoogheemraadschap Delfland, Delft
CWI Hoofdkantoor, Utrecht	Hoogheemraadschap Rijnland, Leiden
CZ, Tilburg	Indicia, Tilburg
De Monarch I, Den Haag	ING Bank, Various locations
De Nieuwe Vorst, Tilburg	Jeroen Bosch Ziekenhuis, Den Bosch
De Rooi Pannen, Tilburg	Joop Ooms Sport, Berkel-Enschot
Dela, Hilvarenbeek	KLM, Amsterdam
Detentiecentrum Schiphol, Schiphol	KLPD, Various locations
Drents Archief, Assen	Koninklijke Douwe Egberts, Amsterdam
DWI Triade, Amsterdam	KPN, Amsterdam
	Kruidvat Retail, Heteren
	KVK, Middelburg

Landal Green Parcs, t Loo
Living Tomorrow, Amsterdam
Maxima Medisch Centrum, Veldhoven
Meeùs, Various locations
Ministerie van Buitenlandse Zaken,
Den Haag
Ministerie van Financiën, Den Haag
MMKA, Arnhem
Muziekcentrum F. Philips, Eindhoven
Nationaal Archief, Den Haag
Naturalis, Leiden
Nederlandse Gasunie, Groningen
Nederlandse Spoorwegen, Various locations
NIFV, Arnhem
Nuon, Alkmaar
Ohra, Arnhem
Orbis Medisch en Zorgconcern, Sittard
OZ, Breda
Parnassia, Various locations
Penitentiare Inrichting, Various locations
Philips, Eindhoven
Politie, Various locations
Prodrive, Eindhoven
Provinciehuis, Arnhem, Den Bosch
PSV De Herdgang, Eindhoven
Rabobank, Various offices
Radboud Ziekenhuis, Nijmegen
Rechtbank, Arnhem, Zwolle
Reed Elsevier, Amsterdam
Rijksmuseum, Amsterdam
Rijkswaterstaat, Various locations
Rijnland Ziekenhuis, Leiderdorp
ROC, Various locations
Roda JC, Kerkrade
Royal Canin, Veghel
Sanoma Uitgevers, Hoofddorp
Sanquin Bloedbank, Various locations
School voor de Toekomst, Den Bosch
Schouwburg, Amstelveen, Deventer

Sensire, Varsseveld
Sony, Heerlen
Sparta, Rotterdam
Stedelijk Museum, Amsterdam
T.S.V. NOAD, Tilburg
Thermaal Bad, Arcen
TNT, Hoofddorp
Transavia, Amsterdam
Twee Steden Ziekenhuis, Tilburg
Universiteit, Various locations
UWV, Various locations
Van Abbemuseum, Eindhoven
VGZ, Eindhoven
VUMC, Amsterdam
Wageningen Universiteit & Researchcentrum,
Wageningen
Waterschap Zuiderzeeland, Lelystad
Willem II, Tilburg
Wipro, High Tech Campus, Eindhoven
Woudschoten Hotel en Conferentiecentrum,
Zeist
Zuiderkerk, Middelburg
Zwembad, Various locations
Zwitserven, Amstelveen

BELGIUM

Alcatel Bell, Antwerpen, Mechelen
AXA, Brussel
Belgacom, Brussel
Blue Green Golf, Durbuy
BMW Garage, Antwerpen
Cap Gemini, Diegem
Centre Sportif, Flobecq
CMG, Berchem
Coca-Cola, Gosselies
Culinor, Destelbergen
Cultureel Centrum Middelkerke, Middelkerke
De Lijn, Brussel
Digipolis, Antwerpen

Elia, Brussel
Erasmus Huis, Leuven
Euromex, Edegem
Europese Commissie, Brussel
Europese Unie, Brussel
Heizel Stadion, Brussel
Hogeschool voor de Kunsten, Antwerpen
Interbrew, Leuven
Janssen Pharmaceutica, Beerse
Karel de Grote-Hogeschool, Antwerpen
Katholieke Hogeschool Kempen, Vorselaar
KBC Bank, Various offices
KPC, Gent
Maria Ziekenhuis Noord-Limburg, Overpelt
Mobistar, Brussel
Nationale Bank, Brussel
NMBS, Brussel
OCMW, Gent
Ordina, Hasselt
Pfizer, Brussel
Plantin bvba, Brussel
Price Waterhouse Coopers, Gent
Provinciehuis aan de Singel, Antwerpen
Sofitel, Brussel
Sportcomplex Leuven, Leuven
Sporthal Haneveld, De Haan
TNT, Luik
Tupperware, Aalst
Union Minière, Olen
Universitair Ziekenhuis, Brussel, Leuven
Universiteit, Gent, Leuven
VRT, Brussel
VTM, Vilvoorde
Zwembad, St. Niklaas en Gent

GERMANY

Aldi KG, Grossbeeren, Konstanz
Allianz Versicherungen, München
BASF, Schwarzeheide, Willstätt

Bayer AG, Krefeld, Leverkusen
Bildungszentrum der Wirtschaft, Essen
BMW AG, Dingolfing
Coca-Cola, Berlin
Deutsche Bahn AG, Saarbrücken
Dresdener Bank, Frankfurt
Dunlop GmbH, Hanau
Esso AG, Ingolstadt
Fachhochschule, Oldenburg
Festhalle, Viersen
Flughafen Köln-Bonn, Köln
Herzog Christoph Gymnasium, Beilstein
IB Bildungszentrum, Ludwigsburg
Lufthansa Technik Hamburg, Hamburg
MAN AG, München
Messe, Essen, Hannover
Nestlé Deutschland AG, Herten
Nürburgring GmbH, Nürburg
Oracle Software, Düsseldorf
Philips, Hamburg
Siemens AG, Müllheim
Thyssen Krupp Stahl, Duisburg
TÜV, Essen
Vodafone/D2, Düsseldorf
Volksbank AG, Marsberg, Hannover

LUXEMBOURG

Air Luxembourg, Luxembourg
Centre guillaume II Ville de Luxembourg,
Luxembourg
Hôpital Intercommunal de Steinfort, Steinfort
ING, Luxembourg
Paleis van Justitie, Luxembourg
Price Waterhouse Coopers, Luxembourg
Salle de Concert, Kirchberg

AUSTRIA

Cultürhaus, Brixen
Universität, Graz, Kapfenberg, Wien

CZECH REPUBLIC

Skoda Showrooms, Czech Republic

DENMARK

Conference Center, Herning
Ford/Mazda Finance, Kopenhagen
Maersk Oil and Gas, Kopenhagen
Ogilvi + Mather, Kopenhagen
Oracle, Ballerup
SAS Business Travel, Kopenhagen

FINLAND

TeliaSonera, Helsinki

FRANCE

Bibliothèque, Tours
Blue Green Golf, Various locations
Lycée Technique, Mersch

GEORGIA

Archstudia, Tbilisi

GREAT-BRITAIN

ABN Amro, London
Bank of England, London
Department of Works and Pensions, Leeds
Orange, London
Porsche, London
Wimbledon, London

DUBAI

KAPSARC, Dubai

IRAN

Embassy H.M., Teheran

MAROC

University Mohammed VI, Casablanca

MONACO

Gramaglia, Monaco

POLAND

HSBC, Warschau

SCOTLAND

Bank of Scotland, Edinburgh

SWITZERLAND

Musée Olympique, Lausanne

CAMEROON

Chancery Office, Yaounde

CANADA

Vancouver Convention Center, Vancouver

INDIA

Ambassade New Delhi, New Delhi

PHILIPPINES

Embassy H.M., Manilla

USA

Airport Atlanta Heartfield, Atlanta
The White House, Washington DC

De Projectinrichter 

www.deprojectinrichter.com

088 - 650 12 34