

# Nenè, not only a chair



MIDJ<sup>®</sup>  
in Italy

Paolo  
Vernier

# Nenè collection

La collezione Nenè racchiude al suo interno concetti di efficienza e praticità. Partendo dalle forme semplici della sedia classica è nata una collezione dal design fresco e contemporaneo, pensata per uso residenziale e collettivo, adatta ad uso interno ed esterno. Disponibile con schienale chiuso o aperto, rivestita o in plastica, con o senza braccioli, con cover lavabile e removibile. Tutte le versioni in plastica rispettano le normative per l'utilizzo in ambienti pubblici, sono impilabili e dotate di trattamento anti-UV. La leggerezza di Nenè è declinata anche nella collezione tavoli, ideali per uso contract e residenziale. Disponibili in diverse misure, materiali e finiture, mantengono la freschezza nel design e la praticità d'uso. La versione con piano quadro e triangolare è impilabile fino a quattro pezzi.

The Nenè collection is based on the concepts of efficiency and practicality. Starting from the simple shapes of classical chair this collection is born with a fresh, contemporary design, suitable for both residential and commercial use, for indoor and outdoor, with closed or opened back, with or without arms, in plastic or upholstered with washable and removable cover. Each plastic version meets regulatory requirements for use in public places (CATAS certification), it is stackable and it is treated against UV rays. The lightness of Nenè is declined even in table collection, in fact they are suitable for both residential and contract use. They are available in different sizes and finishes, keeping a fresh and practical design. Square and triangular top versions are stackable up to 4 pieces.



Sedia  
Chair

# Not only nice

La forma leggera nasconde le mille potenzialità della sedia Nenè.

Un concentrato di leggerezza e solidità, tanto da superare i più severi test di resistenza previsti dalla normativa per l'uso in ambienti pubblici. Impilabile fino a dieci pezzi, realizzata in polipropilene rinforzato con fibra di vetro e trattata con protezione antistatica e anti-UV, è disponibile in otto colori ed è riciclabile al 100%. È possibile personalizzare Nenè con cover removibili e lavabili realizzate in tessuto, ecopelle o pelle.

Nenè è stata creata per arredare ambienti collettivi o domestici, interni o esterni. Per facilitare lo stoccaggio è disponibile il carrello Geoffrey dove Nenè può essere impilata fino a venticinque unità e trasportata senza fatica.

Nenè offre tutti i vantaggi della semplicità interpretata in chiave funzionale.

This light shape of Nenè hides thousands of possibilities. A concentrate of light and strength, exceeding the most stringent stress tests (CATAS certification) to meet the regulatory requirements for use in public areas.

Nenè is stackable up to ten pieces, it is made of fiberglass reinforced polypropylene and it is treated against UV rays and antistatic. This chair is available in eight different colors and it is recyclable up to 100%. It is possible to personalize Nenè with removable and washable cover made of fabric, ecoleather or leather. Nenè has been created for public or domestic use, both indoor and outdoor. Thanks to Geoffrey stacking Nenè is really easy: it is a trolley where it is possible to stock up to twenty-five Nenè chairs and transport them effortlessly.

Nenè offers all the advantages of simplicity interpreted in a functional key.



.01  
NENÈ S polipropilene P05, P06.  
NENÈ S polypropylene P05, P06.

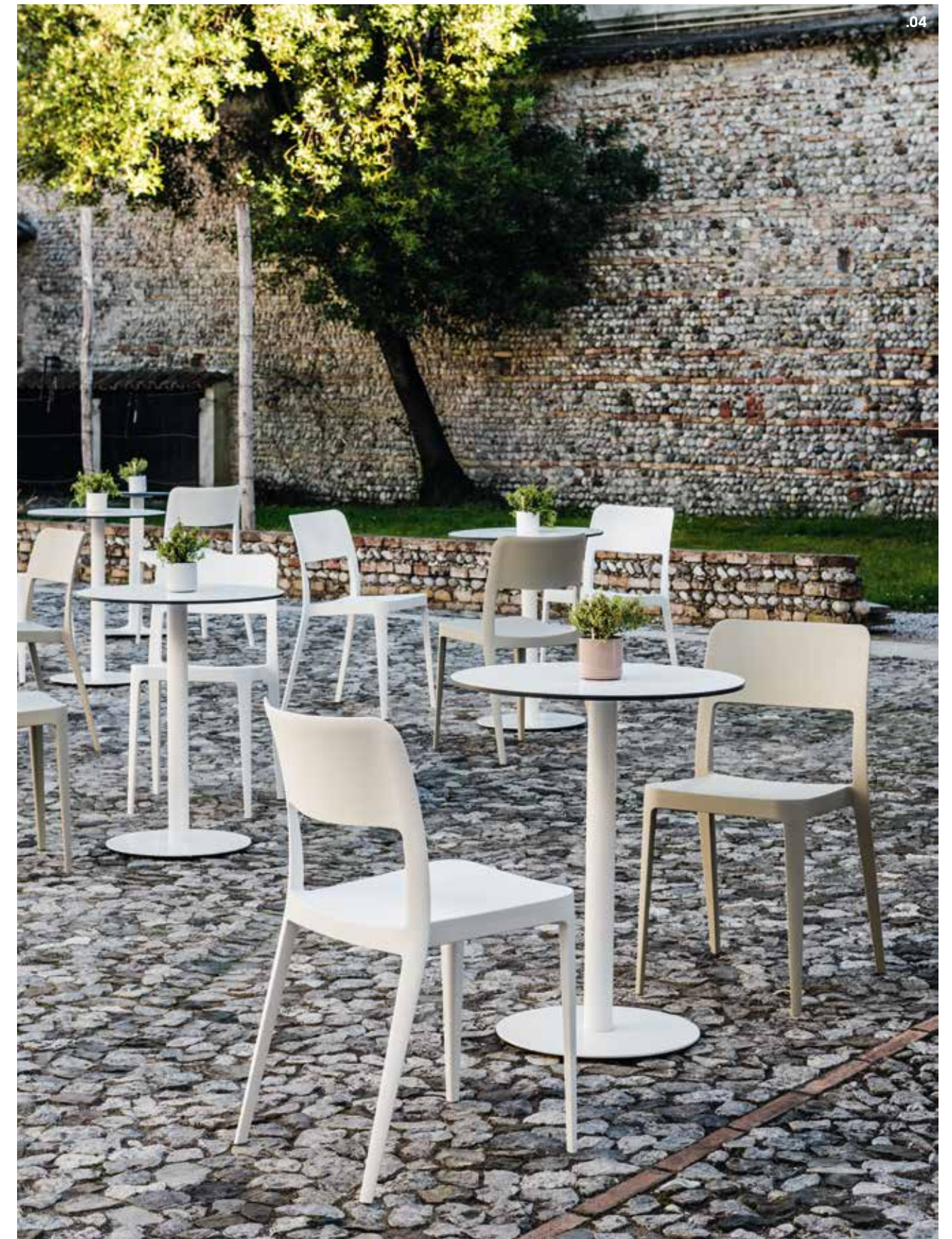

**.02 .03 .04**  
NENÉ S polipropilene P05, P07, SMART basamento  
bistrot acciaio Y, piano LS5.  
NENÉ S polipropilene P05, P07, SMART bistro base  
steel Y, top LS5.



.05  
LUNA basamento bistrot acciaio Y, top hpl LC5; NENE S e NENE PP  
polipropilene P07.  
LUNA bistrot base steel Y, top hpl LC5; NENE S e NENE PP  
potipropilene P07.



**.06 .07**  
NENÉ S polipropilene P04,  
ARMANDO tavolo fisso in acciaio D.  
NENÉ S polypropylene chair P04,  
ARMANDO fix table with steel frame D.



Poltroncina  
Armchair

# Not only strong

Leggerezza, funzionalità e robustezza sono rispettati anche nella versione Nenè con braccioli. Realizzata in polipropilene caricato fibra di vetro a partire da un unico stampo, è disponibile in otto colori. Essenziale e molto versatile, questa sedia è impilabile fino a dieci unità. Nenè è trattata contro i raggi UV e antistatica, realizzata in polipropilene riciclabile, è adatta per arredare qualsiasi spazio esterno o interno, privato o pubblico avendo superato i test previsti dalla normativa. È possibile raggiungere un grado ancor più elevato di confort rivestendo sedile e schienale con cover removibili e lavabili. Per facilitarne lo stoccaggio è disponibile il carrello Geoffrey dove Nenè può essere impilata fino a venticinque pezzi e trasportata senza fatica. Nenè con braccioli è leggera, solida e funzionale senza rinunciare al comfort e ad un design minimale.

Lightness, functionality and robustness are the criteria respected in the Nenè armchair. It is made of polypropylene reinforced glass fiber from a single mold and it is available in eight different colors. This chair is essential and very eclectic, moreover it is stackable up to ten pieces. Nenè is treated against UV rays and antistatic, it is made of recyclable polypropylene, so this means that it is suitable for any indoor or outdoor space, private or public having passed the tests required by the regulations (CATAS certification). In addition, in order to achieve the top of comfort, it is possible to cover the seat and the back with removable and washable materials. For easy stocking, the trolley Geoffrey is available, where Nenè can be stacked up to twenty-five pieces and transported effortlessly. Nenè with armrests is light, solid and functional without sacrificing comfort and minimalist design.



.08  
NENÈ PP polipropilene P06.  
NENÈ PP polypropylene P06.



.09  
NENÉ PP polipropilene P06, P41. NENÉ  
TRIANGOLARE acciaio Y, HPL LC5.  
NENÉ PP polypropylene P06, P41. NENÉ  
TRIANGOLARE steel Y, HPL LC5.





**.10**  
NENÉ PP polipropilene P06, P41.  
TRIANGOLARE acciaio Y, hpl LC5.  
NENÉ PP polypropylene P06, P41. NENÉ  
TRIANGOLARE steel Y, hpl LC5.

**.11**  
NENÉ PP polipropilene P06.  
NENÉ ø70 acciaio Y, hpl LC5.  
NENÉ PP polypropylene P41.  
NENÉ ø70 steel Y, hpl LC5.

Sedia legno  
Wood chair

# Not only traditional

Il calore del legno incontra le linee fluide di Nenè. Il risultato è una sedia preziosa realizzata in legno di frassino modellato artigianalmente in grado di garantire un'eleganza moderna legata alla praticità di una sedia impilabile fino a quattro pezzi. Nenè in legno è adatta ad uso collettivo e domestico richiamando lo spirito della sedia in legno tradizionale ma aumentandone il comfort ed ispirando un clima di convivialità.

The warmth of wood meets the fluid lines of Nenè. The result is a valuable chair made of ash wood modeled by hand, which ensures modern elegance linked to the practicality of a chair that is stackable up to four pieces. The wooden Nenè is suitable for both collective and domestic use, it recalls back the spirit of a traditional wooden chair, but in the meantime it increases its comfort and it inspires an atmosphere of conviviality.



.12  
NENÈ LG legno L40, L26.  
NENÈ LG wood L40, L26



.13  
NENÉ LG sedia legno L26,  
ARMANDO tavolo fisso acciaio D.  
NENÉ LG wooden chair L26,  
ARMANDO fix table steel D.



.14  
NENÉ LG legno L40.  
NENÉ LG wood L40.



.15  
NENÉ LG sedia legno L26, ARMANDO tavolo fisso in acciaio D.  
NENÉ LG wooden chair L26, ARMANDO fix table with steel frame D.

Sedia e poltrona imbottite  
Chair and armchair lined

Not only  
soft

Nenè è compatta, vivace ed espressiva.  
Le già numerosissime varianti della sedia in plastica,  
diventano infinite scegliendola nella versione  
rivestita con pelle o tessuti. Con o senza braccioli,  
con schienale chiuso o aperto, il design senza  
tempo di Nenè diventa elegante e prezioso.  
La sedia e poltroncina, comoda e accogliente,  
si adatta ad ogni situazione.

Nenè is compact, lively and expressive. The already  
numerous variants of this plastic chair, become  
infinite if you choose it in the covered version with  
leather or fabric. With or without armrests, with  
open or closed backrest, the timeless design  
of Nenè becomes elegant and precious.  
The chair and armchair versions, which are elegant  
and comfortable, suit every kind of situation.



.16  
NENÈ SR CF ecopelle 726, NENÈ PR SF ecopelle 722, NENÈ SR SF ecopelle 726, NENÈ PR CF ecopelle 722.  
NENÈ SR CF ecoleather 726, NENÈ PR SF ecoleather 722, NENÈ SR SF ecoleather 726, NENÈ PR CF ecoleather 722.



**.17**  
 NENÉ SR CF ecopelle 718, NENÉ  
 PR SF pelle F09.  
 NENÉ SR CF ecoleather 718,  
 NENÉ PR SF leather F09.



**.18**  
 NENÉ SR SF ecopelle 722,  
 LONDON tavolo fisso 2000x1100, piano VE5.  
 NENÉ SR SF ecoleather 722,  
 LONDON fix table 2000x1100, top VE5.

Cover

# Not only a dress

Nenè è energia, colore e funzionalità. Per rendere la versione sedia o poltrona in plastica veramente unica è possibile abbinare una cover removibile e lavabile sul sedile e sullo schienale per garantire un miglior comfort negli ambienti interni senza rinunciare alla praticità di una sedia da esterno. Le cover sono realizzabili in tessuto, pelle o ecopelle.

Nenè is energy, color and functionality. To make the chair or armchair versions truly unique, it is possible to combine a removable and washable cover for the seat and the backrest in order to ensure the best comfort in indoor environments without sacrificing the convenience of an outdoor chair. Covers are available in fabric, leather or ecoleather.



.19  
NENÈ PP TS polipropilene P41, tessuto 456.  
NENÈ PP TS polypropylene P41, fabric 456.

Tavoli  
Tables

# Not only elegant

Il design fresco ed elegante della collezione Nené contamina anche la collezione tavoli. Disponibili con gambe in metallo verniciato e piani di diverse forme, dimensioni e materiali, racchiudono concetti di efficienza e praticità proponendo nuove forme organiche di tendenza. Ideali per uso contract e residenziale. La versione con piani quadri e triangolari è impilabile fino ad quattro pezzi.

The freshness and elegant design of Nené also contaminates the table collection. They are available with painted metal legs and tops of different shapes, sizes and materials. They combine in themselves the efficiency and convenience concepts by proposing new forms of organic trends suitable for contract and residential use. Square and triangular top versions can be stacked up to four pieces.



**.20**  
NENÉ Ø70 acciaio Y, top hpl LC5; NENÉ TRIANGOLARE acciaio Y, top hpl LC;  
NENÉ 140x90 acciaio Y, top legno L40; NENÉ 90x90 acciaio Y, top hpl LC5.  
NENÉ Ø70 steel Y, top hpl LC5; NENÉ TRIANGOLARE steel Y, top hpl LC5;  
NENÉ 140x90 steel Y, top wood L40; NENÉ 90x90 steel Y, top hpl LC5.





.21  
NENÉ 140x90 acciaio Y, top legno L40; NENÉ S polipropilene P05.  
NENÉ 140x90 steel Y, top wood L40; NENÉ S polypropylene P05.



.22  
NENÉ 140x90 acciaio Y, top legno L40; NENÉ S  
polipropilene P05.  
NENÉ 140x90 steel Y, top wood L40; NENÉ S  
polypropylene P05.

Designer and Industrial process

# Cordovado, Pordenone, Italy



Guarda il video di Nene  
Watch the Nene's video

È il presidente di Midj, Paolo Vernier, a firmare il design di Nene. I trent'anni di esperienza e di lavoro appassionato hanno portato alla realizzazione di una sedia semplice che parte dalla classica forma della sedia a quattro gambe e le da una nuova anima, fresca e leggera, funzionale e adattabile a qualsiasi uso. In Midj lo sviluppo di un modello è seguito passo dopo passo partendo dal suo disegno fino alla tiratura industriale: l'intero processo produttivo e creativo nasce nel quartier generale di Cordovado, nel nord est italiano, dov'è radicato un saper fare unico in tutto il mondo.

It's the Midj chairman, Paolo Vernier, to sign the design of Nene. The thirty years of experience and passionate work led to the realization of a simple chair that part from a classic form of the four-leg chair, and from a new core, fresh and light, practical and adaptable to any use.

Midj in the development of a model is followed step by step starting from its design until the Industrial circulation: the entire production and creative process born in the headquarters of Cordovado, in northeastern Italy, where is rooted a know-how unique in the world.



## Nenè S

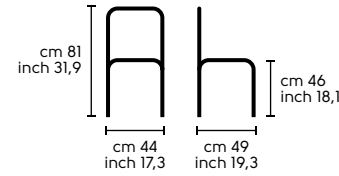

Seduta impilabile in polipropilene con schienale aperto. Adatta per uso esterno.  
Stackable chair in polypropylene with open backrest. Suitable for outdoor use.

**Accessori - Accessories**  
Cover removibile - Removable cover  
Carrello Geoffrey- Geoffrey trolley

**Impilabilità - Stackability**  
Fino a 4 pz per la spedizione - Up to 4 pcs for shipping  
Fino a 12 pz impilata - Up to 12 pcs stacked  
Fino a 25 pz impilata su carrello Geoffrey- Up to 25 pcs stacked on trolley Geoffrey

**Test di resistenza - Resistance test**  
EN 1728:2012 level 3° strict  
EN 15373:2007 level 3° strict  
ANSI-BIFMA X5.1-2011/12

Struttura - Frame

Polipropilene - Polypropylene



## Nenè PP

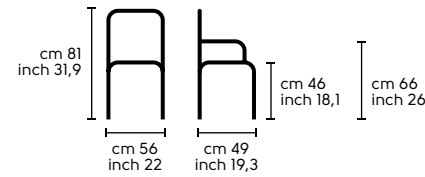

Poltrona impilabile in polipropilene con schienale aperto. Adatta per uso esterno.  
Stackable armchair in polypropylene with open backrest. Suitable for outdoor use.

**Accessori - Accessories**  
Cover removibile - Removable cover  
Carrello Geoffrey - Geoffrey trolley

**Impilabilità - Stackability**  
Fino a 4 pz per la spedizione - Up to 4 pcs for shipping  
Fino a 10 pz impilata - Up to 10 pcs stacked  
Fino a 20 pz impilata su carrello Geoffrey- Up to 20 pcs stacked on trolley Geoffrey

**Test di resistenza - Resistance test**  
EN 1728:2012 level 3° strict  
EN 15373:2007 level 3° strict  
ANSI-BIFMA X5.1-2011/12  
EN 16139:2013, level L2 extreme

Struttura - Frame

Polipropilene - Polypropylene



## Nenè S LG

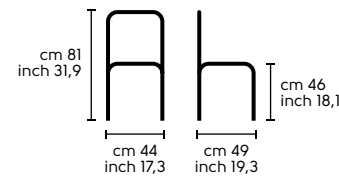

Sedia impilabile in legno con schienale aperto. - Stackable wooden chair with open backrest.

**Accessori - Accessories**  
Carrello Geoffrey- Geoffrey trolley

**Impilabilità - Stackability**  
Fino a 4 pz per la spedizione - Up to 4 pcs for shipping  
Fino a 8 pz impilata - Up to 8 pcs stacked  
Fino a 16 pz impilata su carrello Geoffrey- Up to 16 pcs stacked on trolley Geoffrey

**Test di resistenza - Resistance test**  
EN 16139:2013, level L2 extreme

Struttura - Frame

Legno tinto - Lacquered wood



## Nenè SR CF

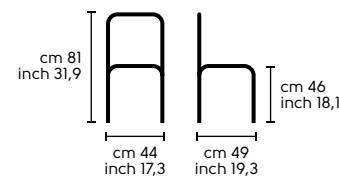

Seduta con struttura in polipropilene con schienale aperto completamente rivestita.  
Chair with frame in polypropylene with open backrest totally upholstered.

**Impilabilità - Stackability**  
Non impilabile - Not stackable

**Test di resistenza - Resistance test**  
EN 1728:2012 level 3° strict  
EN 15373:2007 level 3° strict  
ANSI-BIFMA X5.1-2011/12

Rivestimenti - Upholstery

Pelle - Leather  
Ecopelle - Ecoleather  
Tessuto - Fabric

Vedi campionario per scegliere il colore - Check the swatches for the complete colours

## Nenè SR SF

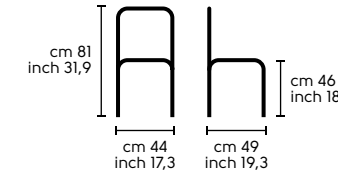

Seduta con struttura in polipropilene con schienale chiuso completamente rivestita.  
Chair with frame in polypropylene with closed backrest totally upholstered.

**Impilabilità - Stackability**  
Non impilabile - Not stackable

**Test di resistenza - Resistance test**  
EN 1728:2012 level 3° strict  
EN 15373:2007 level 3° strict  
ANSI-BIFMA X5.1-2011/12

Rivestimenti - Upholstery

Pelle - Leather  
Ecopelle - Ecoleather  
Tessuto - Fabric

Vedi campionario per scegliere il colore - Check the swatches for the complete colours

## Nenè PR CF

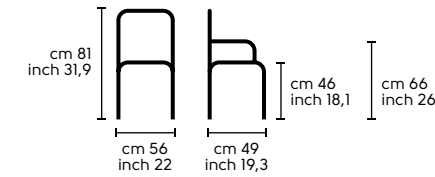

Poltrona con struttura in polipropilene con schienale aperto completamente rivestita.  
Armchair with frame in polypropylene with open backrest totally upholstered.

**Impilabilità - Stackability**  
Non impilabile - Not stackable

**Test di resistenza - Resistance test**  
EN 1728:2012 level 3° strict  
EN 15373:2007 level 3° strict  
ANSI-BIFMA X5.1-2011/12

Rivestimenti - Upholstery

Pelle - Leather  
Ecopelle - Ecoleather  
Tessuto - Fabric

Vedi campionario per scegliere il colore - Check the swatches for the complete colours

## Nenè PR SF

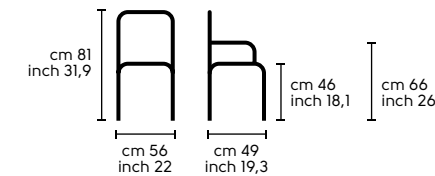

Poltrona con struttura in polipropilene con schienale chiuso completamente rivestita.  
Armchair with frame in polypropylene with closed backrest totally upholstered.

**Impilabilità - Stackability**  
Non impilabile - Not stackable

**Test di resistenza - Resistance test**  
EN 1728:2012 level 3° strict  
EN 15373:2007 level 3° strict  
ANSI-BIFMA X5.1-2011/12

Rivestimenti - Upholstery

Pelle - Leather  
Ecopelle - Ecoleather  
Tessuto - Fabric

Vedi campionario per scegliere il colore - Check the swatches for the complete colours

## Nenè CAP



Rivestimenti - Upholstery

Pelle - Leather  
Ecopelle - Ecoleather  
Tessuto - Fabric

Vedi campionario per scegliere il colore - Check the swatches for the complete colours

Cover lavabile e removibile per sedia Nenè S in polipropilene. - Washable and removable cover for the chair Nenè S in polypropylene.

## Nenè S TS

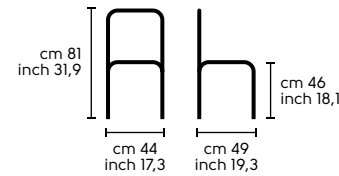

Sedia impilabile in polipropilene con schienale aperto. Sedile e schienale rivestiti con cover removibile. - Stackable chair in polypropylene with open backrest. Seat and backrest upholstered with removable cover.

**Accessori - Accessories**  
Cover removibile - Removable cover  
Carrello Geoffrey- Geoffrey trolley

**Impilabilità - Stackability**  
Fino a 4 pz per la spedizione - Up to 4 pcs for shipping  
Fino a 8 pz impilata - Up to 8 pcs stacked  
Fino a 20 pz impilata su carrello Geoffrey- Up to 20 pcs stashed on trolley Geoffrey

**Test di resistenza - Resistance test**  
EN 1728:2012 level 3\* strict  
EN 15373:2007 level 3\* strict  
ANSI-BIFMA X5.1-2011/12

### Struttura - Frame

Polipropilene - Polypropylene



### Rivestimenti - Upholstery

Pelle - Leather  
Ecopelle - Ecoleather  
Tessuto - Fabric

Vedi campionario per scegliere il colore - Check the swatches for the complete colours

## Nenè PP TS

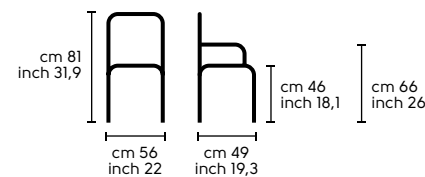

Poltrona impilabile in polipropilene con schienale aperto. Sedile e schienale rivestiti con cover removibile. - Stackable armchair in polypropylene with open backrest. Seat and backrest upholstered with a removable cover.

**Accessori - Accessories**  
Cover removibile - Removable cover  
Carrello Geoffrey - Geoffrey trolley

**Impilabilità - Stackability**  
Fino a 4 pz per la spedizione - Up to 4 pcs for shipping  
Fino a 8 pz impilata - Up to 8 pcs stacked  
Fino a 20 pz impilata su carrello Geoffrey- Up to 20 pcs stashed on trolley Geoffrey

**Test di resistenza - Resistance test**  
EN 1728:2012 level 3\* strict  
EN 15373:2007 level 3\* strict  
ANSI-BIFMA X5.1-2011/12  
EN 16139:2013, level L2 extreme

### Struttura - Frame

Polipropilene - Polypropylene



### Rivestimenti - Upholstery

Pelle - Leather  
Ecopelle - Ecoleather  
Tessuto - Fabric

Vedi campionario per scegliere il colore - Check the swatches for the complete colours

## Nenè Ø70, Ø80

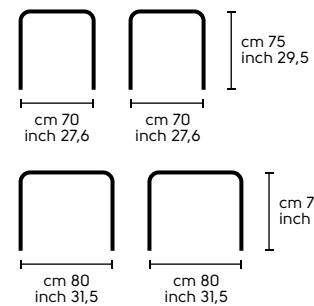

Tavolo fisso con base a tre gambe in acciaio verniciato bianco o nero e piano tondo in HPL o melaminico disponibile nelle misure Ø70 cm e Ø80 cm. - Fix table with three legs-base in white or black lacquered steel available with HPL or melamine top Ø70 cm or Ø80 cm.

### Struttura - Frame

Acciaio - Steel



### Piano - Top

HPL bordo nero - HPL black core

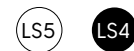

HPL bordo bianco - HPL white core



Melaminico - melamine

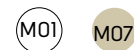

## Nenè Triangolare

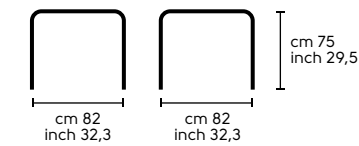

Tavolo fisso con base a tre gambe in acciaio verniciato bianco o nero e piano triangolare in HPL o melaminico. - Fix table with three legs-base in white or black lacquered steel available with HPL or melamine top.

**Impilabilità - Stackability**  
Fino a 4 pz - Up to 4 pcs

### Struttura - Frame

Acciaio - Steel



### Piano - Top

HPL bordo nero - HPL black core



HPL bordo bianco - HPL white core



Melaminico - melamine

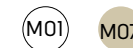

## Nenè 75x75

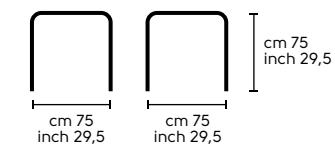

Tavolo fisso con base a quattro gambe in acciaio verniciato bianco o nero e piano quadro con angoli arrotondati in HPL o melaminico. - Fix table with four legs-base in white or black lacquered steel available with square HPL top with rounded corners.

**Impilabilità - Stackability**  
Fino a 4 pz - Up to 4 pcs

### Struttura - Frame

Acciaio - Steel



### Piano - Top

HPL bordo nero - HPL black core



HPL bordo bianco - HPL white core



Melaminico - melamine

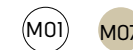

## Nenè 85x85

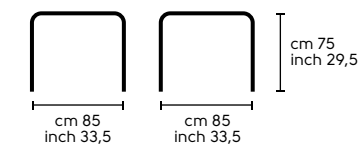

Tavolo fisso con base a quattro gambe in acciaio verniciato bianco o nero e piano quadro con angoli arrotondati in HPL o melaminico. - Fix table with four legs-base in white or black lacquered steel available with square HPL top with rounded corners.

**Impilabilità - Stackability**  
Fino a 4 pz - Up to 4 pcs

### Struttura - Frame

Acciaio - Steel



### Piano - Top

HPL bordo nero - HPL black core



HPL bordo bianco - HPL white core



Melaminico - melamine

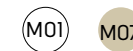

## Nenè 140x90

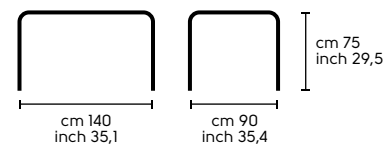

Tavolo fisso con base a quattro gambe in acciaio verniciato bianco o corda e piano rettangolare con angoli arrotondati in impiallacciato o melaminico. - Fix table with four legs-base in white or sand lacquered steel available with rectangular top in veneered wood or melamine with rounded corners.

Struttura - Frame

Acciaio - Steel



Piano - Top

Impiallacciato - Veneered wood



Melaminico - Melamine

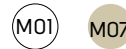

## Luna

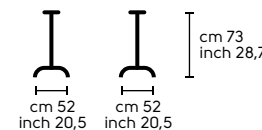

Basamento bistrot con struttura a quattro razze in acciaio verniciato. Piano disponibile in diverse forme e misure. - Bistrò base with four-ways base in painted steel. Top available in different shape and size.

**Misure piani - Top size**  
 Ø cm 60 - Ø inch 23,6  
 Ø cm 70 - Ø inch 27,6  
 Ø cm 80 - Ø inch 31,5  
 cm 60x60 - inch 23,6x23,6  
 cm 70x70 - inch 27,6x27,6  
 cm 80x80 - inch 31,5x31,5

Struttura - Frame

Acciaio - Steel



Piano - Top

HPL bordo nero - HPL black core



HPL bordo bianco - HPL white core



Melaminico - melamine

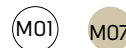

## Geoffrey carrello - Trolley



Carrello universale in acciaio su ruote per stockaggio di tutti i modelli di sedia impilabile della collezione Midj. - Trolley with wheels for stocking all the stackable chairs of Midj collection.

**Misure - Size**  
 H cm 72 - H inch 28,3  
 L cm 98 - W inch 38,6  
 P cm 44 - D inch 17,3

Struttura - Frame

Acciaio - Steel



Midj S.p.A. si riserva di apportare modifiche e/o migliorie di carattere tecnico ed estetico ai propri modelli e prodotti in qualsiasi momento e senza preavviso.

I colori visualizzati sono puramente indicativi e possono variare rispetto alla realtà.

Tutti i diritti riservati.

Midj S.p.A. reserves the right to modify its equipment at any time without updating this manual.

The colors shown are for guidance only and may be different than the reality.

All rights reserved.

Midj S.p.A. se réserve le droit de modifier ses produits à tout moment et sans mise à jour de ce manuel.

Les couleurs sont à titre indicatif seulement et peuvent être différentes de la réalité.

Tous droits réservés.

Midj behält sich das Recht vor, seine Produkte jederzeit zu ändern und zu verbessern, ohne Ankündigung.

Die abgebildeten Farben sind nur als Hinweise und können anders als die Realität.

Alle Rechte vorbehalten.

Midj S.p.A. se reserva el derecho de modificar sus productos en cualquier momento sin actualizar este manual.

Los colores muestran como guía y pueden diferir de la realidad.

Todos los derechos reservados.

Компания оставляет за собой право вносить изменения в любое время без обновления этого руководства.

Цвета, показанные в качестве единственного ориентира и может отличаться от действительности.

Все права защищены.



MIDJ S.p.A.  
 Via Madonna di Campagna, 2/A  
 33075 Cordovado (PN) - Italy  
 T +39.0434690122  
 www.midj.com  
 info@midj.com

Project: Vassalli associati  
 Art direction: Gianluca Vassalli  
 Graphic design: Alessandro Orteschi  
 Stylist: Barbara Marsiletti  
 Location photo: Emanuele Tortora  
 Still life photo: Salmaso fotografia  
 Reportage photo: Alessandro Lazzarin  
 Color separation: GM Studio 1  
 Print: Sincromia

MIDJ<sup>®</sup>  
in Italy