

ADD S

Francesco Rota | 2016

www.deprojectinrichter.com
088 - 650 12 34



ADD S

Francesco Rota | 2016

Not only a chair, not only a table. The ADD system is enhanced with modular office furniture: metal units with D. 45 cm, available in three different heights. The double-fronted feature of the storage unit - open or closed with drawers or doors in a variety of finishes - allows it to be positioned in the middle of a room to meet the needs of an office environment that is increasingly open to versatile design layouts.



Legs



Storage frames

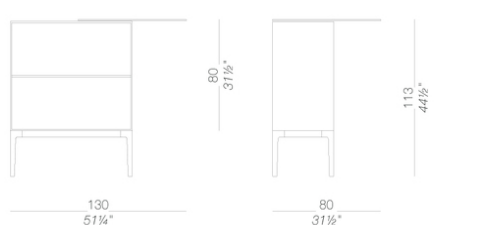
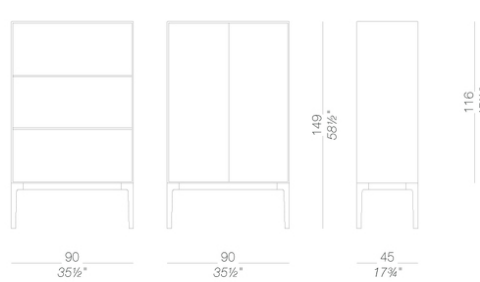
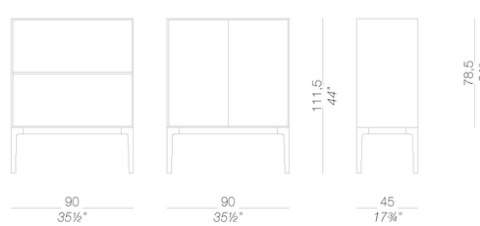
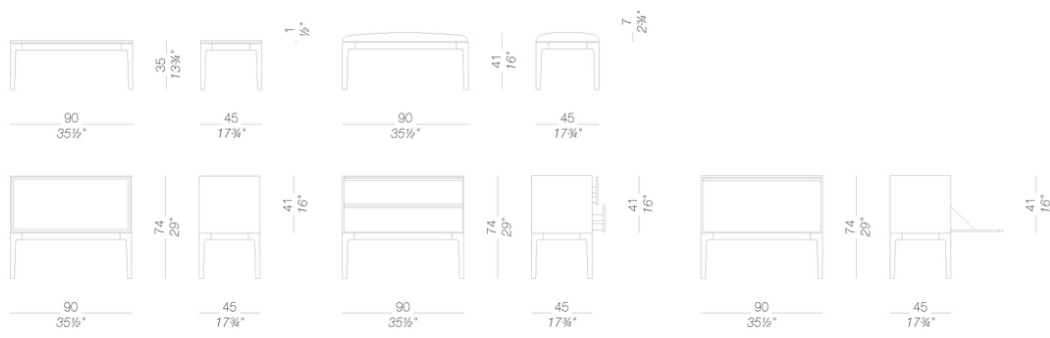
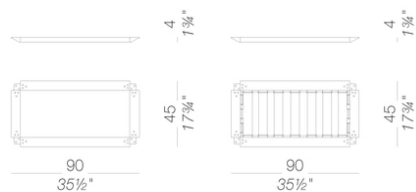

drawers

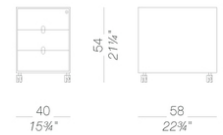

ADD S

Francesco Rota | 2016

Modular system of storage and seating with aluminium frame and legs. Storage units in powder coated metal with shelves, drawers, doors and backs in several finishes. Table tops in white Hpl Fenix®. Seating with elastic support, cushions in molded fire retardant foam with polyester fiber and removable fabric, leather or eco-leather. Also available a drawer unit on castors with lock. ADD System can be combined with the ADD table system and ADD seating system.

ADD S

Francesco Rota | 2016

frame



powder coating
white
1 Colors

drawer unit on castors



powder coating
black
1 Colors

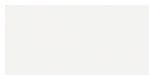

powder coating
white
1 Colors

upholstery for drawers and doors



wood
blached oak
1 Colors

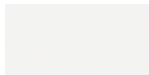

lacquered
lacquered
2 Colors

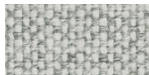

fabric
Hallingdal 65
47 Colors

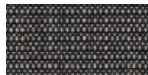

fabric
Canvas 2
40 Colors



fabric
Steelcut Trio 3
48 Colors



fabric
Remix 2
24 Colors



fabric
Clara 2
24 Colors



fabric
Fiord
24 Colors

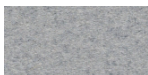

fabric
Divina MD
24 Colors



fabric
Divina Melange 2
24 Colors



fabric
Tonica 2
39 Colors



fabric
Medley
37 Colors



fabric
Swing
24 Colors

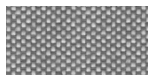

fabric
Maya
1 Colors



fabric
Jet
1 Colors



fabric
Laser J Flash
1 Colors



ecoleather
GRIMM FR
24 Colors

backs

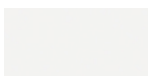

powder coating
white
1 Colors



wood
blached oak
1 Colors

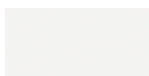

lacquered
lacquered
2 Colors



metal
perforated metal
2 Colors



fabric
Hallingdal 65
47 Colors



fabric
Canvas 2
40 Colors



fabric
Steelcut Trio 3
48 Colors



fabric
Remix 2
24 Colors



fabric
Clara 2
24 Colors



fabric
Fiord
24 Colors



fabric
Divina MD
24 Colors



fabric
Divina Melange 2
24 Colors



fabric
Tonica 2
39 Colors



fabric
Medley
37 Colors



fabric
Swing
24 Colors

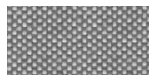

fabric
Maya
1 Colors



fabric
Jet
1 Colors



fabric
Laser J Flash
1 Colors



ecoleather
GRIMM FR
24 Colors

ADD S

Francesco Rota | 2016

cushion

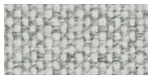

fabric
Hallingdal 65
47 Colors



fabric
Canvas 2
40 Colors



fabric
Steelcut Trio 3
48 Colors



fabric
Remix 2
24 Colors



fabric
Clara 2
24 Colors



fabric
Fiord
24 Colors



fabric
Divina MD
24 Colors



fabric
Divina Melange 2
24 Colors



fabric
Tonica 2
39 Colors



fabric
Medley
37 Colors



fabric
Swing
24 Colors

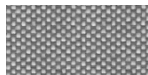

fabric
Maya
1 Colors



fabric
Jet
1 Colors



fabric
Laser J Flash
1 Colors



ecoleather
GRIMM FR
24 Colors

top



HPL 10 mm
HPL fenix
2 Colors

consult the portfolio for the range of colors, fabrics, eco-leather, soft-leather.

use and maintenance instructions

Clean all parts in wood, leather, fabric and metal with a damp cloth or a diluted neutral cleaner. Do not use cleaners with alcohol, bleach, solvent or abrasive products. Any liquid spilt on the product must be wiped up immediately. When lifting or moving the product, hold it on the structure and not under the seat. The product should not be subjected to unbalanced weights, as it is designed for a proper rest on the foothold (on four legs or on the base). Our company relieves from any responsibility in case of damage caused to fragile floors. Avoid any improper use of the product: do not step on the product, on the footrest or on the armrests. Avoid any movements that could compromise the proper functionality of the product or the safety of the users. Wood and leather, being natural materials, could be easily damaged. Small impurities or imperfections are within quality standard range. Do not expose the product to weather conditions or atmospheric agents, nor to heat sources over 40°C. Also products for outdoor use could be afflicted by atmospheric agents. The product could undergo possible exterior changes due to particular exposure to heat, humidity and saltiness. An appropriate and frequent maintenance and cleaning of the product enhances its durability. The product could change colour and shade, if exposed to direct sunlight. Maintenance has to be carried out by experienced staff. Dispose of the package only after assembling the product, in order to avoid the loss of ironmongery and components. Once the product has been dismantled, the product itself or its components must be given to the public garbage disposal system, according to the legislation in force.